



AEROMOTIVE
Part # 18354
Dual Phantom Fuel Pump / Baffle System
For Nissan Patrol
INSTALLATION INSTRUCTIONS

This product is not legal for sale or use on emission-controlled vehicles except when used as a direct replacement part matching OEM specification.

WARNING!



Always be aware of flammable situations. Drilling and grinding can be potential ignition sources. Extinguish all open flames, prohibit smoking and eliminate all sources of ignition in the area of the vehicle and workspace before proceeding with the installation. Ensure you are working in a well ventilated area with an approved fire extinguisher nearby.

WARNING!



etc.

Installation of this product requires modification to a fuel tank/ the fuel system, failure to satisfy all safety considerations will result in fire, explosion, injury and/or loss of life to yourself and/or others. All fuel system components **MUST** be located as far from heat sources as possible, like exhaust, engine block,

WARNING!



Mechanical and hydraulic lifting devices can tip over or lower accidentally due to incorrect maneuvering or technical errors. A falling object can cause injury and/or loss of life to yourself and/or others. When working under the vehicle, always use stands, and ensure that the ground or floor is stable and level. Never crawl under a vehicle which is only supported by a jack.

WARNING!



The fuel system is under pressure. Do not open the fuel system until the pressure has been relieved. Refer to the appropriate vehicle service manual for the procedure and precautions for relieving the fuel system pressure.

CAUTION!



When installing this product always wear safety glasses and other appropriate safety apparel. A drilling operation will cause flying metal chips. Flying metal chips can cause eye injury.

CAUTION:



Installation of this product requires detailed knowledge of automotive systems and repair procedures. We recommend that this installation be carried out by a qualified automotive technician. Careless installation of this product can result in damage to the product, injury or loss of life to yourself and/or others.

Compatible Fuels:

Pump Gas
Race Gas
E85
Alcohol/Ethanol

Parts Included:

1ea Fuel Pump Assembly	1ea M4 x .70 x 16mm Pan Head Phillips Screw
2ea Fuel Pump Strainer	1ea M4 Washer
1ea Fuel Pump Foam Baffle Assembly	1ea M4 Lock Washer
6ea M5 x .80 x 10mm Socket Head Cap Screws	1ea M4 Nut
6ea M5 Washers	1ea Sending Unit Bracket
6ea M5 Lock Washers	2ea Sending Unit Wire Pigtails

Tools / Supplies Needed:

Phillips Screwdriver
M4 Allen Wrench
Wire Strippers/Crimpers
Wire Cutters

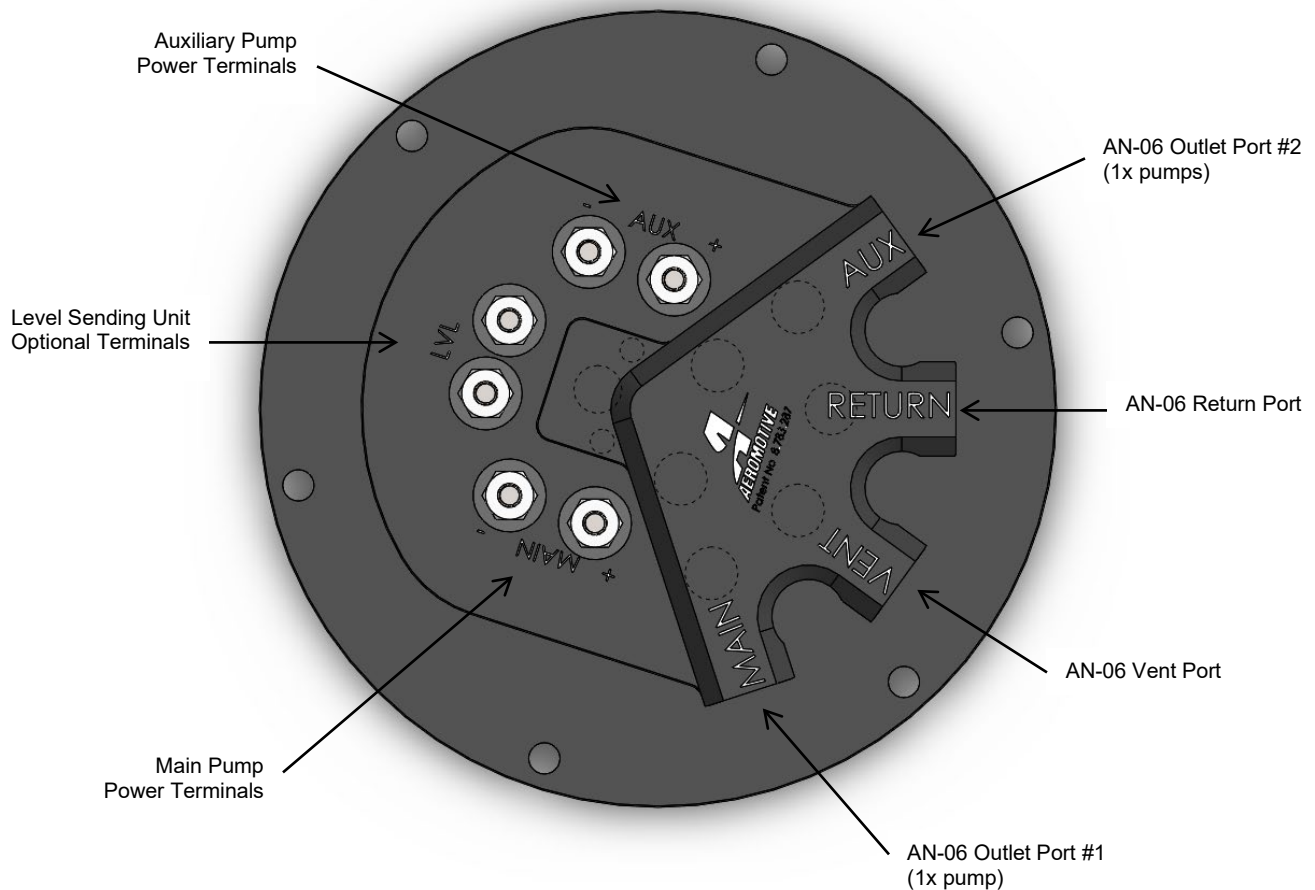

The enclosed Aeromotive fuel pump assembly utilizes an o-ring sealed AN-06 style feed, return and vent ports. These ports seal with o-rings; these ports are **NOT PIPE THREAD** and utilize **NO THREAD SEALANT**.

The fuel pumps used in this system are the Aeromotive Stealth 450 (part # 11545). To ensure proper pump function and life, we strongly recommend the following:

- Utilize AN-08 (EFI) size high pressure fuel lines, fittings and o-rings for all connections from the fuel tank to the engine, including the supply and return lines. Use fitting p/n 15649 (ORB -6 Male x -8 AN Male Flare) to connect -8 AN hose to outlet cap ports.
- Install a 10 micron post-filter (Aeromotive p/n 12321 or 12377 for individual outlets or 12311 for all three pumps)
- Install a remote-mount rollover valve. It must be mounted in a vertical position and mounted as high or higher than your filler tube.
- Fuel pump wiring should be 8 gauge wire and triggered with a relay rated for a minimum of 40 amps for the “Auxiliary” (2x pumps) control, 10 gauge wire and 20 amps minimum for the “Main” (1x pump) control.
- A return style or bypass regulator must be used (Aeromotive p/n 13305 or 13134 for EFI) with the exception of applications running an ECU that supports a returnless systems where the ECU controls fuel pressure via PWM.
- This product is intended for use with an EFI system. Use in a carbureted application may require use of a secondary return line in order to keep return line pressure within carburetor operating limits.

Failure to follow the above recommendations may result in fuel leakage, bursting of the fuel lines, poor vehicle performance and/or decreased fuel pump life! Improper installation will void all warranties for this product!

Pump Specifications:

	18354 Kit, (Pump 2x 11545)
Outlet pressure/typical flow:	40 psi / 3x 430 LPH @ 13.5 V 60 psi / 3x 381 LPH @ 13.5 V
Continuous Operating Range:	5 psi – 65 psi @ 13.5 V
Pump internal By-Pass Pressure:	120 psi
Current Draw:	3x 15.3 amps @ 40 psi

Aeromotive Commonly Used Fittings

15607 AN-08 ORB to AN-08 Flare (Inlet/outlet/vent fitting)	For AN-08 fuel lines
15641 AN-08 ORB to AN-10 Flare (Inlet/outlet/vent fitting)	For AN-10 fuel lines
15610 AN-10 ORB to AN-08 Flare (fuel filter fitting)	For AN-08 fuel lines
15608 AN-10 ORB to AN-10 Flare (fuel filter fitting)	For AN-10 fuel lines

Aeromotive AN-10 Fuel Filter P/N's

12301 Red 10-micron Fuel Filter	12377 Black 10-micron Fuel Filter, Male Ends
12321 Black 10-micron Fuel Filter	12311 Black Hardcoat 10-Micron Fuel Filter
12351 Chrome 10-micron Fuel Filter	

Aeromotive system components are not legal for sale or use on emission controlled motor vehicles.

CAUTION:



Aeromotive Phantom Components, including the Phantom 450 Stealth Pump and the patented Foam and Bladder Baffle assembly, have been thoroughly tested for use in common pump gas, non-oxygenated racing gas, ethanol including E85 from corn, and petroleum based (not-bio) diesel fuel. Blending fuels and/or additives, including cleaners, stabilizers or octane boosters, cannot be tested and could result in damage to Phantom system components or other components in the fuel system. These failures cannot be anticipated and may not be covered under warranty. Contact the Aeromotive Tech Department with any questions on blending of fuels and/or use of additives.

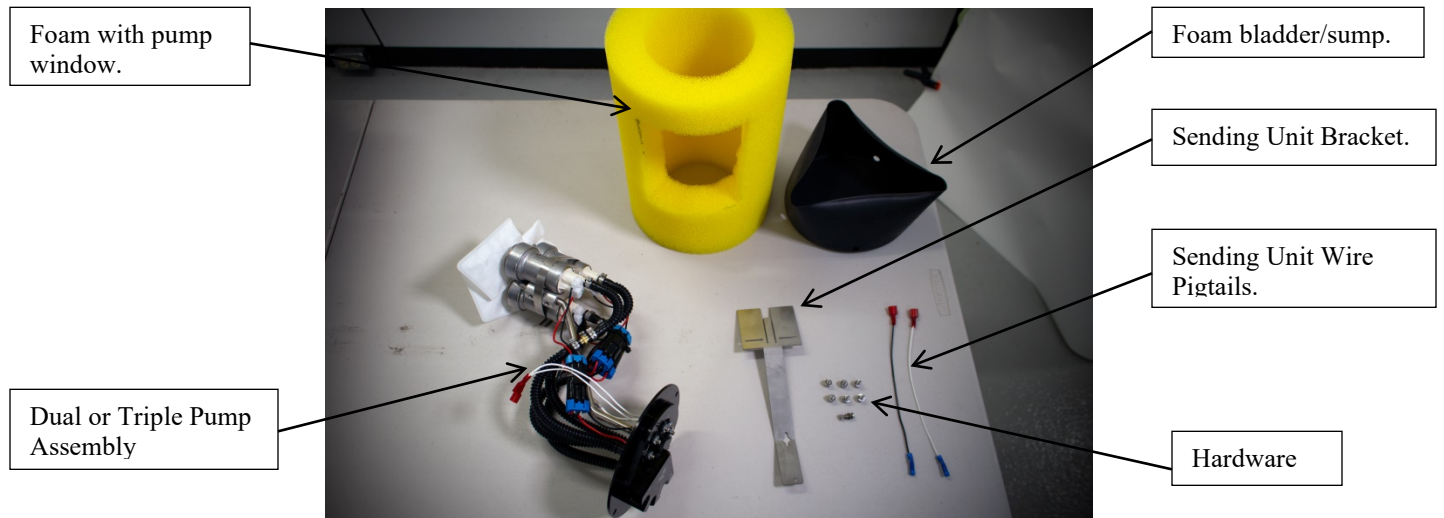

The following steps are typical of most installations:

1. Once the engine has been allowed to cool, disconnect the negative battery cable and relieve the fuel system pressure, referring to the appropriate vehicle service manual for the procedure and precautions for doing so.
2. Raise the vehicle on stable level ground and support it with jack stands.
3. Referring to the appropriate vehicle service manual for instructions, drain, disconnect any electrical and fuel system component connections and remove the OEM fuel tank. The removal of the vehicles exhaust system may be necessary for fuel tank removal.



The fuel tank must be professionally cleaned prior to the new pump installation in order to remove all traces of any combustible fluids. Failure to properly clean and remove all combustible fluids from the fuel tank will result in injury or loss of life to yourself and/or others.

4. With the fuel tank on your preferred work surface, remove the 6 – M5 screws holding the factory pump/sending unit assembly in the tank. The factory screws will not be used during re-assembly.



5. Carefully remove the factory pump/sending unit from the tank, be sure to not damage the float rod/fuel sending unit as this will be reused during re-assembly. **Remove the factory o-ring from the groove surrounding the sending unit hole, discard this o-ring as a new one (not included) is required for re-assembly.**



6. Locate the two wires (one black and one white) that are connected to the fuel level sending unit, using the wire cutters, cut these wires free from the outlet cap, leaving as much wire attached to the sending unit as possible.
7. Using the wire strippers, strip approximately 10mm of wire insulation from the black and white wires connected to the factory fuel level sending unit.
8. Locate the two provided wire pigtails, (one black and one white). Using the wire crimpers, crimp each pigtail butt connector to the corresponding wire (white to white, black to black).

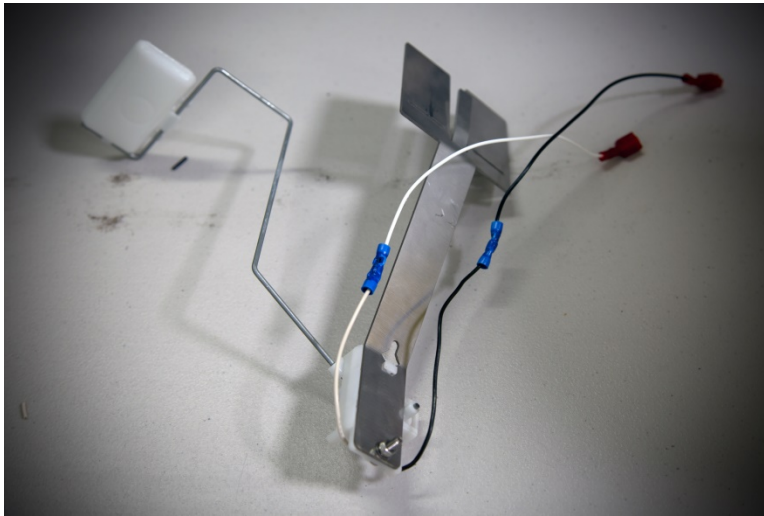

9. Locate the provided sending unit bracket; install the factory fuel level sending unit on the bracket by inserting the plastic tab feature on the back of the factory fuel level sending unit into the slot on the bracket. Next, slide the fuel level sending unit up until the hole on the sending unit is aligned with the hole on the bracket. Secure the fuel level sending unit to the bracket with the provided M4 x 16mm screw, washer, lock washer and nut.

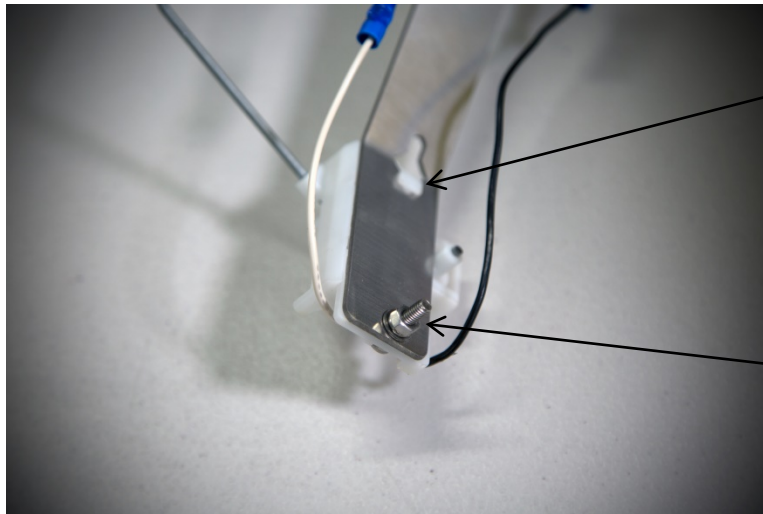

Plastic tab inserted in sending unit slot.

M4 x 16mm screw, washer, lock washer, and nut.

10. Insert the sending unit bracket/fuel level sender assembly into the tank; attach the bracket to the factory fuel sump inside the tank. To attach the bracket, push the sending unit bracket downward onto the edge of the fuel sump with the two small tabs. The (2) larger flanges of the bracket should go on the outside of the sump box; the small “finger” flange should go on the inside of the factory sump. Push the sending unit down until the small tabs snap into the two slots on the sending unit bracket. Once the tabs are locked in, press the “finger” flange towards the side of the sump and press the (2) larger flanges in the same manner towards the opposing side of the sump. This helps ensure the tabs are firmly locked into the slots on the sending unit bracket.

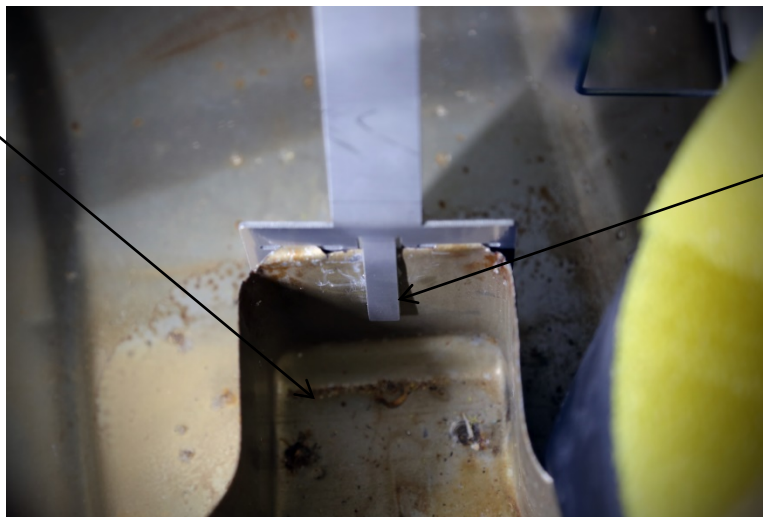

Factory fuel tank sump.

Finger flange of sending unit bracket.

11. Carefully move the black and white wires from the sending unit out of the way (towards the filler neck side of the tank). Ensure the wires are not wrapped around the fuel level sending unit arm and that they won't hinder the arm's range of motion.
12. Locate the provided foam and bladder. Install the bladder onto the foam, the bladder should be placed on the end of the foam that has the most material between the “window” and the edge. Ensure the bladder conforms to the foam without wrinkles or distortion.



13. Insert the foam and bladder assembly into the tank. To insert the foam, grasp the bottom of the foam/bladder and roll up tightly in order for the assembly to fit through the factory sending unit hole. Insert the end of the foam with the bladder installed first. Once the foam/bladder is inside the tank, position the “window” so it faces the filler neck side of the tank. The foam/bladder assembly should sit just outside of the factory fuel pump sump. Ensure the bladder is not distorted on the foam; the bladder should be uniform all the way around the foam. If the bladder needs to be repositioned, this can usually be done while inside the tank.



Window in foam facing towards tank filler neck.

Tank filler neck.

14. Pull the black and white wires from the sending unit out of the sending unit hole and position to one side.
15. Install a new factory replacement o-ring (not included) around the pump assembly, carefully maneuver it around all hoses and wires. Let the o-ring hang loose just under the outlet cap.
16. Loosely insert the pump assembly into the sending unit hole with the three pumps pointed towards the “window” in the foam. Allow the pump assembly to sit loosely inside the tank while you connect the black and white wires from the sending unit to the two white wires connected to the “LVL” terminals. Push the quick disconnects together until the connectors are fully seated.

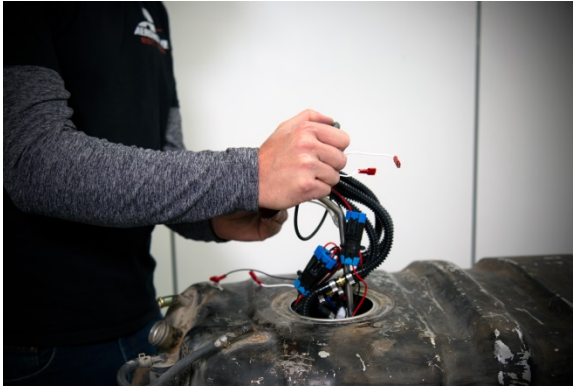

17. Fully install the pumps inside the tank (inside foam/bladder) by carefully rotating the pump assembly and pushing down in order to get the pumps positioned through the “window” in the foam and into the “sump” portion of the foam/bladder.



O-Ring Seated in Groove.

18. Ensure the o-ring is positioned correctly in the groove around the sending unit hole, then push the outlet cap down against the o-ring. **Note the orientation of the outlet cap: the return port of the outlet cap should be pointed towards the hose barb protruding from the tank that connects to the factory vent plumbing. Caution: Take special care to ensure that the fuel pump wires are fully inside of the tank and will not be pinched in between the pump assembly and the fuel tank during assembly.** Finally, use the 6 provided M5 socket head cap screws, washers, and lock washers to secure the outlet cap to the tank. Start all 6 screws by hand and then using the M4 Allen wrench, tighten in a cross pattern.



19. Prep the new tank by making all the necessary connections (feeds, return, vent, and electrical) before placing tank in vehicle. In most cases, once the tank is placed in the vehicle these connections will not be accessible.

Note: Tank vent must be at least 6" above the top of the tank if a roll-over valve is used (highly recommended).

20. The diagram below represents a typical EFI setup.

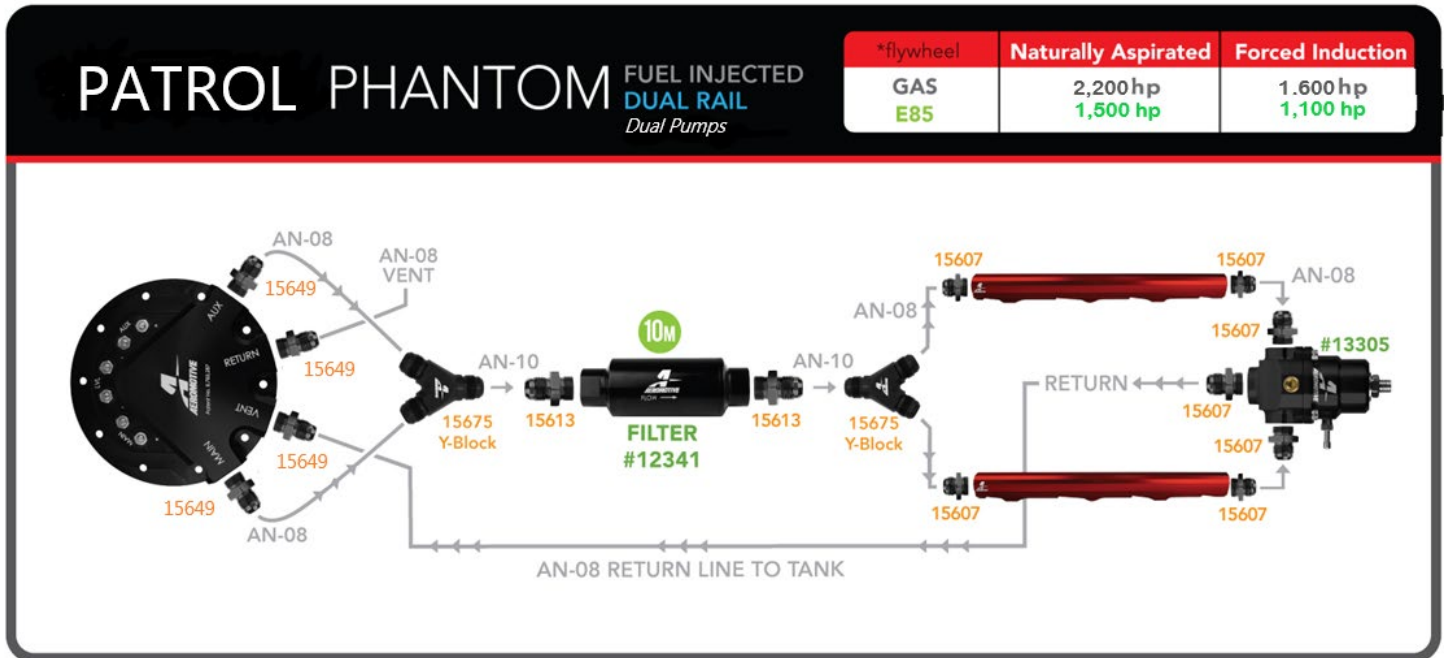

Note: Be sure to route all electrical wires clear of any moving suspension or drivetrain components and any exhaust components! Protect wires from abrasion and road obstructions or debris.

21. Reinstall the fuel tank in the vehicle. In some cases it may be necessary to space the fuel tank down to allow additional clearance for the new pump outlet, top plate and fittings. Additional fabrication may be necessary to gain clearance in extreme cases.
22. Now route the feed and return lines under the vehicle and secure them to the chassis. It's recommended to install a post-filter between the fuel pump and the engine (see Aeromotive part #12321/12377/12341). Place the filter in a location that is clear of suspension and exhaust system components and easy to get to for servicing.

Note: Be sure to route all fuel lines clear of any moving suspension or drivetrain components, and any exhaust components! Protect fuel lines from abrasion and road obstructions or debris.

23. Connect electrical power (12 VDC) to each of the fuel pump power terminals. Make sure you use stranded, insulated copper wire, in the sizes shown, with matching crimp-type connectors for all connections. **CAUTION: The pump must be connected through a fused power source and not connected directly to the battery.** Connect each of the Aeromotive fuel pumps as shown in the following diagram: **NOTE: ONE RELAY AND FUSE PER PUMP "SIDE" (MAIN OR AUXILIARY TERMINALS).**

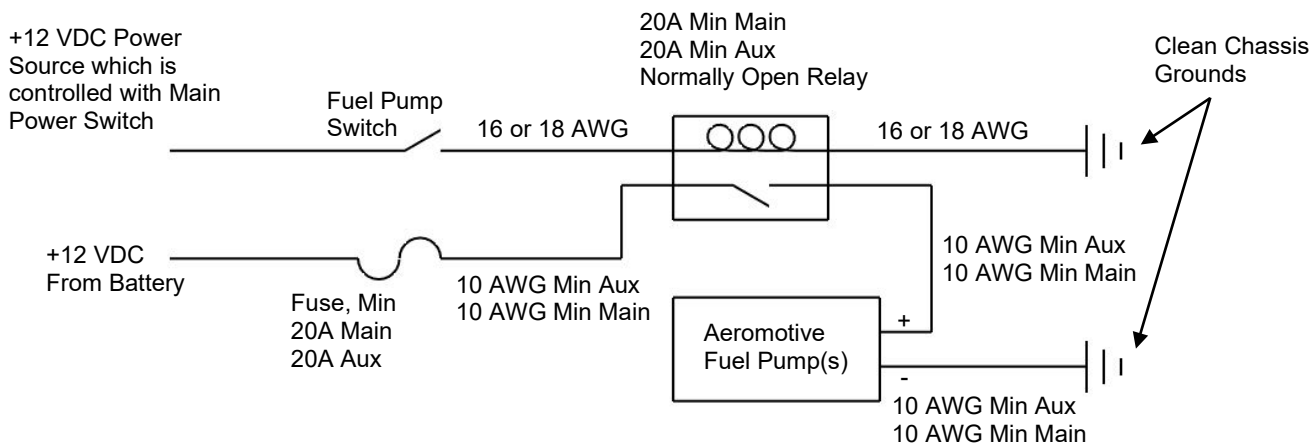

CAUTION: While performing the following steps, if any fuel leaks are detected, immediately turn the fuel pump OFF, remove any spilled fuel and repair the leak(s) before proceeding!

24. Turn the fuel pump ON **without starting the engine**, allow the pump to run for several seconds and check the fuel pressure. If there is no pressure, turn the fuel pump OFF, wait one minute, then turn the fuel pump ON and recheck the pressure. Repeat this fuel pump OFF and ON procedure until the fuel pressure gauge registers pressure or you detect a fuel leak. It may be necessary to loosen the fuel line fitting at the pressure regulator to bleed off excessive air in the system. Tighten any fuel line fittings which were loosened and insure that any spilled fuel is cleaned up and removed from the vicinity of the vehicle. If no pressure is registered on the gauge after running the pump for several seconds and you have found no leaks, check all fuel and electrical connections to determine the cause.
25. Once the fuel pressure gauge registers pressure, start the engine. The gauge on the fuel pressure regulator should register between 35 and 60 psi for EFI. Now adjust the fuel pressure regulator to the desired setting.

Test drive the vehicle to insure proper operation and re-check the fuel system for leaks. **If any leaks are found, immediately discontinue use of the vehicle and repair the leak(s)!**

Contact Us

RGA NUMBER REQUIRED FOR ALL RETURNS TO AEROMOTIVE.

To obtain an RGA number, please call (913) 647-7300 and ask for the Returns and Repairs department or complete the online form under the "Rebuilds" section at www.aeromotiveinc.com.

- **Shipping & Returns**
Aeromotive Inc.
11414 W 79th Street.
Lenexa, KS 66214

General Inquiries and Tech Line: (913) 647-7300

General Email: info@aeromotiveinc.com

Tech Email: tech@aeromotiveinc.com

The Aeromotive Tech Lines are open Monday through Friday from 9:30AM to 5:00PM Central Standard Time.



WARNING: This product can expose you to chemicals, including chromium, which is known to the State of California to cause cancer or birth defects or other reproductive harm. For more information, visit: www.p65Warnings.ca.gov

AEROMOTIVE, INC. LIMITED WARRANTY

This Aeromotive Product, with proof of purchase dated on or after January 1, 2003, is warranted to be free from defects in materials and workmanship for a period of one year from the original date of purchase. No warranty claim will be valid without authentic, dated proof of purchase.

This warranty is to the original retail purchaser and none other and is available directly from Aeromotive and not through any point of distribution or purchase.

If a defect is suspected, the retail purchaser must contact Aeromotive directly to discuss the problem, possible solutions and obtain a Return Goods Authorization (RGA), if deemed necessary by the company. Please call 913-647-7300 and dial option 3 for the technical service dept. All returns must be shipped freight pre-paid to the company and with valid RGA before they will be processed.

Aeromotive will examine any product returned with the proper authorization to determine if the failure resulted from a defect or from abuse, improper installation, misapplication or alteration. Aeromotive will then, at it's sole discretion, return, repair or replace the product.

If any Aeromotive product is determined defective, buyer's exclusive remedy is limited in value to the sale price of the good. In no event shall Aeromotive be liable for incidental or consequential damages.

Aeromotive expressly retains the right to make changes and improvements in any product it manufactures and sells at any time. These changes and improvements may be made without notice at any time and without any obligation to change the catalogs or printed materials.

Aeromotive expressly retains the right to discontinue at any time and without notice any Aeromotive product that it manufactures or sells.

This warranty is limited and expressly limits any implied warranty to one year from the date of the original retail purchase on all Aeromotive products.

No person, party or corporate entity other than Aeromotive shall have the right to: determine whether or not this Limited Warranty is applicable to any Aeromotive product, authorize any action whatsoever under the terms and conditions of this Limited Warranty, assume any obligation or liability of any nature whatsoever on behalf of Aeromotive under the terms and conditions of this Limited Warranty.

This Limited Warranty covers only the product itself and not the cost of installation or removal.

This Limited Warranty is in lieu of and expressly excludes any and all other warranties, expressed or implied. This Limited Warranty gives you specific legal rights, and you may also have other rights which vary from state to state.