



1965-66 Ford F-100

Gen 5 Evaporator Kit
(751649)



18865 Goll St. San Antonio, TX 78266
Phone: 800-862-6658
Sales: sales@vintageair.com
Tech Support: tech@vintageair.com
www.vintageair.com



www.vintageair.com

Table of Contents

Cover.....	1
Table of Contents.....	2
Packing List/Parts Disclaimer.....	3
Information Page.....	4
Wiring Notice.....	5
Control Panel Information.....	6
Engine Compartment Disassembly, Condenser Assembly and Installation, Compressor and Brackets, Pulleys.....	7
Passenger Compartment Disassembly.....	8
Passenger Compartment Disassembly (Cont.), Defrost Duct Installation.....	9
Firewall and Passenger-Side Fender Modification.....	10
Firewall Insulation, A/C Hose and Kick Panel Cap Installation.....	11
A/C Hose and Kick Panel Cap Installation (Cont.).....	12-15
Evaporator Bracket and Hardline Installation.....	16-17
Wiring Harness Installation.....	18-19
Wiring Harness Installation, Evaporator Installation.....	20
Evaporator Installation.....	21-22
Lubricating O-rings, Properly Seated O-ring Land.....	23
Drain Hose Installation.....	24
Heater Hose & Heater Control Valve Installation.....	25
A/C and Heater Hose Routing.....	26
Passenger-Side Louver Installation.....	27
Driver-Side Louver Installation.....	28
Center Louver and Control Panel Installation.....	29-30
Final Wiring from Engine Bay.....	31-32
Final Wiring from Inside Cab.....	33
Compressor Lead Installation.....	34
Final Steps: Installation Check.....	35
Final Steps: Completing the Install.....	36
Duct Hose Routing.....	37
Quality Crimp Guideline.....	38
Gen 5 Wiring Diagram.....	39
Gen 5 Wiring Connection Instruction.....	40
Operation of Controls.....	41
Troubleshooting Guide.....	42
Troubleshooting Guide (Cont.), Advanced Diagnostics and Troubleshooting Guide.....	43
Packing List.....	44



www.vintageair.com

Packing List: Evaporator Kit (751649)

No.	Qty.	Part No.	Description
1.	1	765125	Gen 5 Magnum Module with 444 ECU
2.	1	791649	Accessory Kit

**** Before beginning installation, open all packages and check contents of shipment. Please report any shortages directly to Vintage Air within 15 days. After 15 days, Vintage Air will not be responsible for missing or damaged items.**

1



Gen 5 Magnum Module
with 444 ECU
765125

2

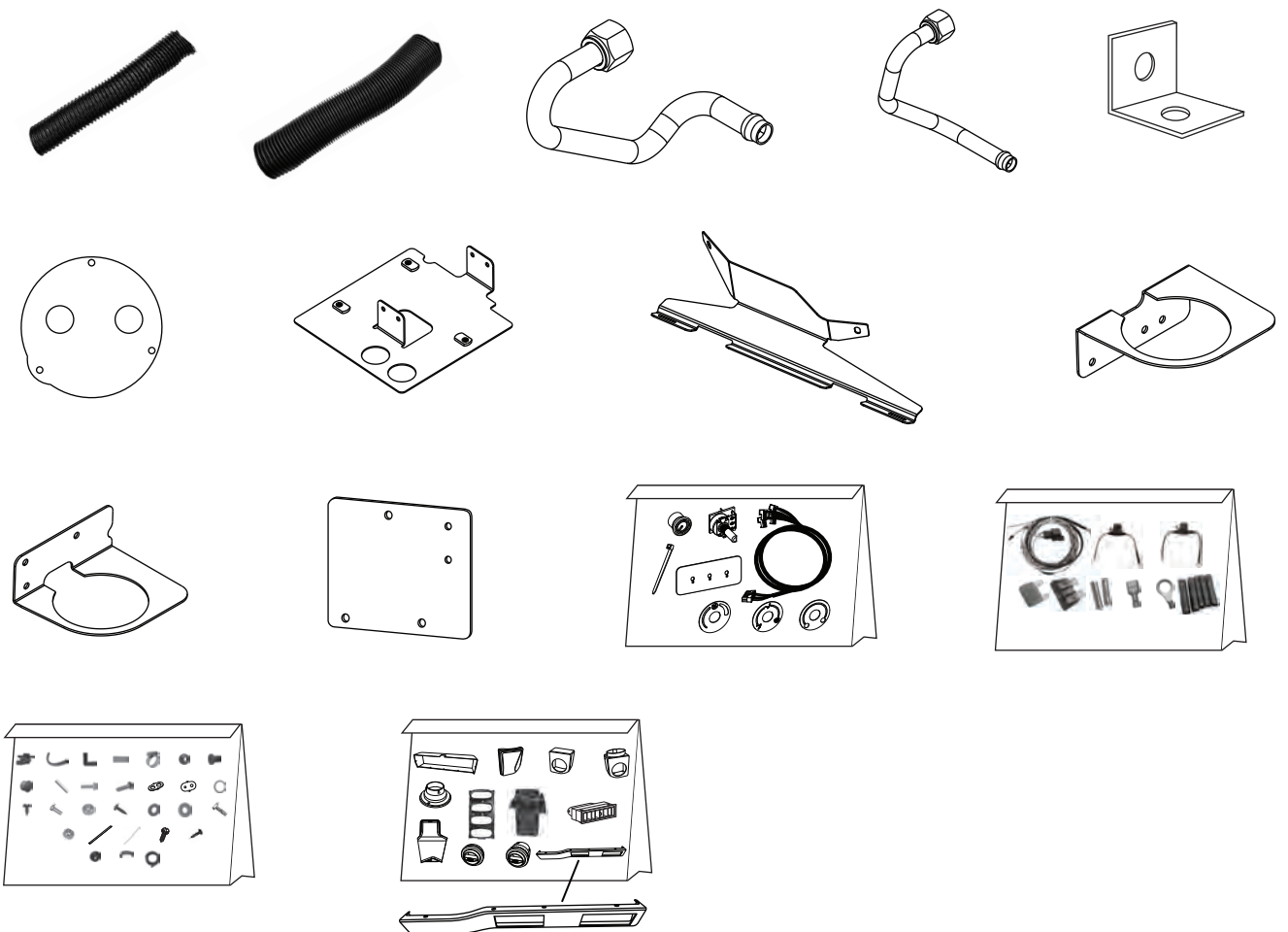

Accessory Kit
791649

NOTE: Images may not depict actual parts and quantities. Refer to packing list for actual parts and quantities.



www.vintageair.com

Important Notice—Please Read

For Maximum System Performance, Vintage Air Recommends the Following:

NOTE: Vintage Air systems are designed to operate with R134a refrigerant only. Use of any other refrigerant could damage your A/C system and/or vehicle, and possibly cause a fire, in addition to potentially voiding the warranties of the A/C system and its components.

Refrigerant Capacities:

Vintage Air System: 1.8 lbs. (28.8 oz.) or 816 grams of **R134a**, charged by weight with a quality charging station or scale. **NOTE: Use of the proper type and amount of refrigerant is critical to system operation and performance.**

Other Systems: Consult manufacturer's guidelines.

Lubricant Capacities:

New Vintage Air-Supplied Sanden Compressor: No additional oil needed (Compressor is shipped with proper oil charge).

All Other Compressors: Consult manufacturer (Some compressors are shipped dry and will need oil added).

Safety Switches

Your Vintage Air system is equipped with a binary pressure safety switch. A binary switch disengages the compressor clutch in cases of extreme low pressure conditions (refrigerant loss) or excessively high head pressure (406 PSI) to prevent compressor damage or hose rupture. A trinary switch combines Hi/Lo pressure protection with an electric fan operation signal at 254 PSI, and should be substituted for use with electric fans. Compressor safety switches are extremely important since an A/C system relies on refrigerant to circulate lubricant.

Service Info:

Protect Your Investment: Prior to assembly, it is critical that the compressor, evaporator, A/C hoses and fittings, hardlines, condenser and receiver/drier remain capped. Removing caps prior to assembly will allow moisture, insects and debris into the components, possibly leading to reduced performance and/or premature failure of your A/C system. This is especially important with the receiver/drier.

Additionally, when caps are removed for assembly, **BE CAREFUL!** Some components are shipped under pressure with dry nitrogen.

Evacuate the System for 35-45 Minutes: Ensure that system components (Drier, compressor, evaporator and condenser) are at a temperature of at least 85°F. On a cool day, the components can be heated with a heat gun **or** by running the engine with the heater on before evacuating. Leak check and charge to specifications.

Bolts Passing Through Cowl and/or Firewall:

To ensure a watertight seal between the passenger compartment and the vehicle exterior, for all bolts passing through the cowl and/or firewall, Vintage Air recommends coating the threads with silicone prior to installation.

Heater Hose (not included with this kit):

Heater hose may be purchased from Vintage Air (Part#31800-VUD) or your local parts retailer. Routing and required length will vary based on installer preference.



www.vintageair.com

Important Wiring Notice—Please Read

Some vehicles may have had some or all of their radio interference capacitors removed. There should be a capacitor found at each of the following locations:

- 1. On the positive terminal of the ignition coil.**
- 2. If there is a generator, on the armature terminal of the generator.**
- 3. If there is a generator, on the battery terminal of the voltage regulator.**

Most alternators have a capacitor installed internally to eliminate what is called “whining” as the engine is revved. If whining is heard in the radio, or just to be extra cautious, a radio interference capacitor can be added to the battery terminal of the alternator.

It is also important that the battery lead is in good shape and that the ground leads are not compromised. There should be a heavy ground from the battery to the engine block, and additional grounds to the body and chassis.

If these precautions are not observed, it is possible for voltage spikes to be present on the battery leads. These spikes come from ignition systems and charging systems, and from switching some of the vehicle’s other systems on and off. Modern computer-operated equipment can be sensitive to voltage spikes on the power leads, which can cause unexpected resets, strange behavior and/or permanent damage.

Vintage Air strives to harden our products against these types of electrical noise, but there is a point where a vehicle’s electrical system can be degraded so much that nothing can help.

Radio interference capacitors should be available at most auto and truck parts suppliers. They typically are cylindrical in shape, a little over an inch long and a little over a half-inch in diameter, and they have a single lead coming from one end of the cylinder with a terminal on the end of the wire, as well as a mounting clip which is screwed into a good ground on the vehicle. The specific value of the capacitance is not too significant in comparison to ignition capacitors that are matched with the coil to reduce pitting of the points.

- Care must be taken, when installing the compressor lead, not to short it to ground. The compressor lead must not be connected to a condenser fan or to any other auxiliary device. Shorting to ground or connecting to a condenser fan or any other auxiliary device may damage wiring or the compressor relay, and/or cause a malfunction.
- When installing ground leads on Gen 5 systems, the blower control ground and ECU ground must be connected directly to the negative battery post.
- For proper system operation, the heater control valve must be connected to the ECU.



www.vintageair.com

Control Panel Information—Please Read

The Vintage Air SureFit™ system for your 1965-66 Ford F-100 includes provisions for a control panel consisting of (3) individual rotary potentiometers with black plastic knobs and their respective labels (See Photo A, below). As an **optional upgrade**, black aluminum fluted knobs (Part # 497005) are available for additional purchase (See Photo B, below). These may be installed at the time of system installation or anytime thereafter.



Photo A



Photo B

Vintage Air also offers an **optional upgrade control panel kit** for the 1965-66 Ford F-100 that features our stylish Streamline control panel (See Photo C, below). Available in both Polished and Black Anodized, it may be installed at the time of system installation or retrofitted anytime thereafter with a simple modification to the center louver bezel. **NOTE: Additional purchase of Vintage Air Kit # 491644 or 491645 is required. See bit.ly/vapanelupgrade for installation instructions.**



Photo C



www.vintageair.com

Engine Compartment Disassembly

NOTE: Before starting the installation, check the function of the vehicle (horn, lights, etc.) for proper operation, and study the instructions, illustrations, photos & diagrams. Retain OEM bolts, washers and nuts, as some hardware will be reused.

Perform the following:

1. Disconnect the battery.
2. Place a jack stand under the axle bar on the passenger side of the vehicle (See Photo 1, below), and remove the passenger-side front tire.
3. Drain the radiator.
4. Remove the (2) heater hoses from where they attach to the heater assembly at the firewall (discard) (See Photo 2, below).

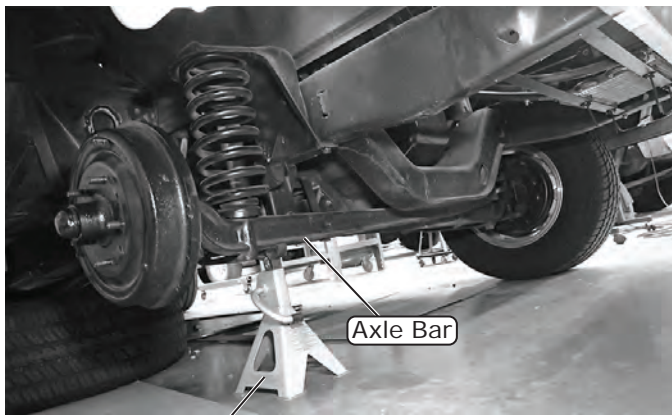

Photo 1

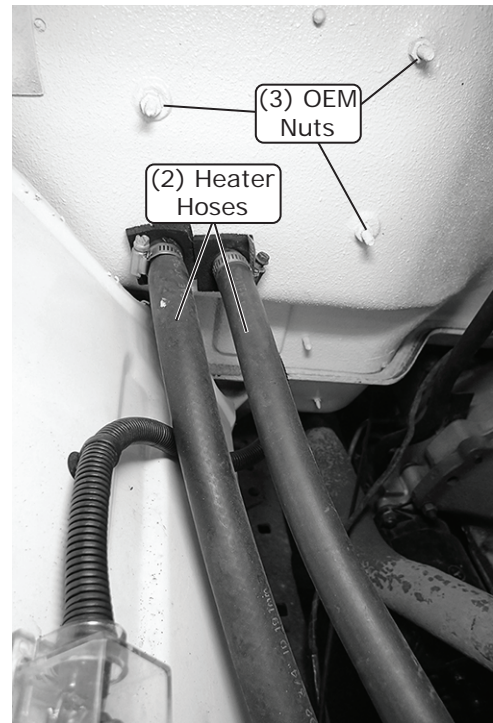

Photo 2

Condenser Assembly and Installation

1. Refer to separate instructions included with the condenser kit to install the condenser.
2. Binary switch installation (Refer to condenser instructions).

Compressor and Brackets

1. Refer to separate instructions included with the bracket kit to install the compressor bracket.

Pulleys

1. In most instances, the belt lengths will remain the same.



www.vintageair.com

Passenger Compartment Disassembly

Perform the following:

1. Remove the glove box by removing (7) screws (discard) (See Photo 1, below).
2. Remove the (2) defrost vents by removing (2) screws on each vent (retain) (See Photos 2 and 3, below).
3. Detach the defrost hoses from the heater assembly and remove them (discard) (See Photos 3 and 4, below).
4. Disconnect all wires from behind the heater fan control (See Photos 5 and 6, below).
5. Remove the cable attached to the heater assembly by removing (1) screw (See Photo 4, below).

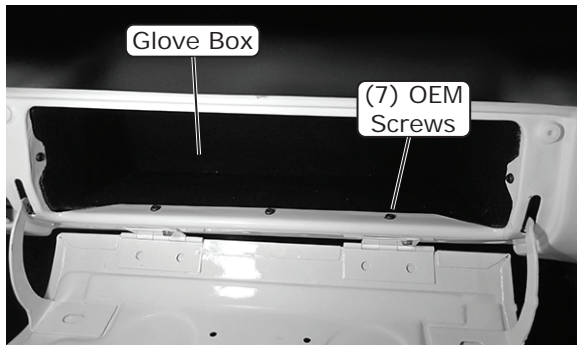

Photo 1

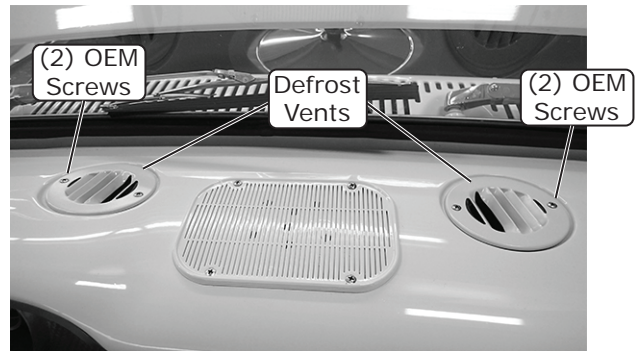

Photo 2



Photo 3

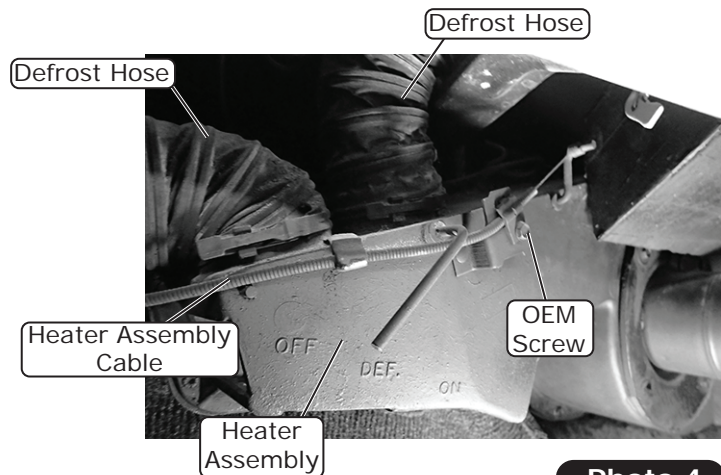

Photo 4



Photo 5

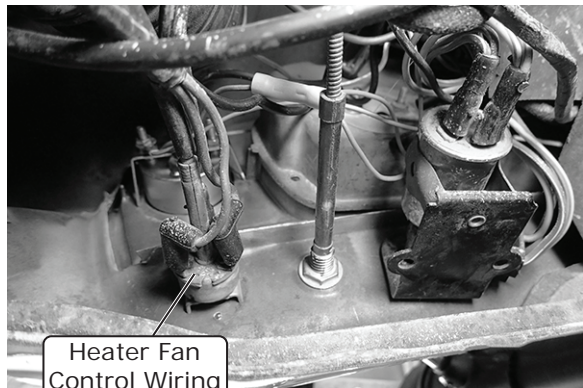

Photo 6



www.vintageair.com

Passenger Compartment Disassembly (Cont.)

6. Remove the heater assembly by removing (3) nuts from the engine side of the firewall (discard) (See Photo 2, Page 7, and Photo 7, below).
7. Remove the kick panel duct by removing (3) screws (discard, but retain screws) (See Photo 8, below).
8. Remove the dash support brace located under the ashtray by removing (2) screws (discard) (See Photos 9 and 10, below).

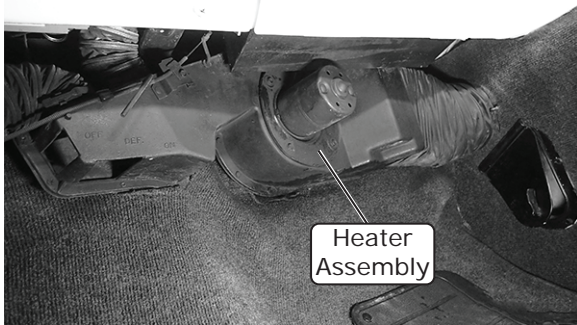

Photo 7

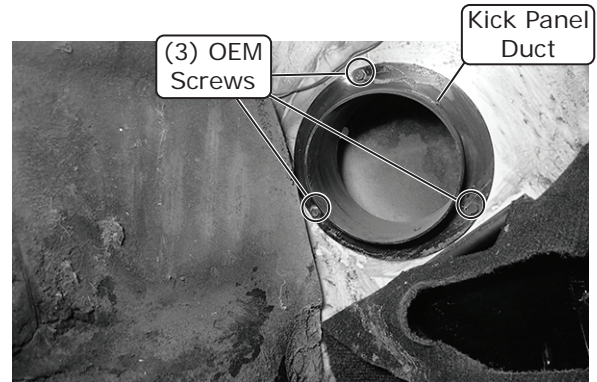

Photo 8

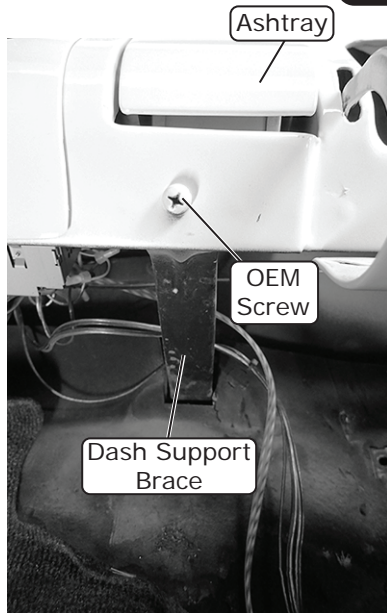

Photo 9

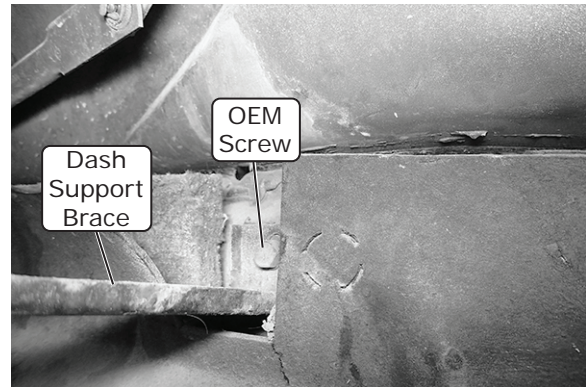

Photo 10

Defrost Duct Installation

1. Install (2) new defrost ducts into the dash using the OEM screws (See Photo 1, below).

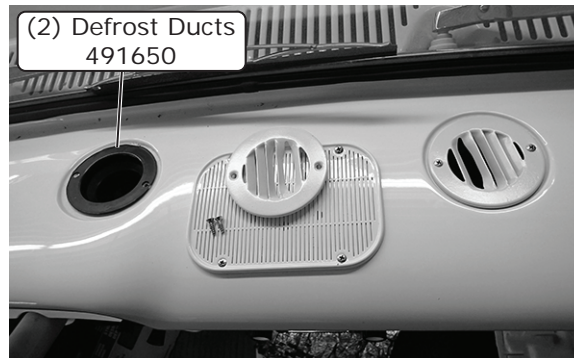

Photo 1



www.vintageair.com

Firewall and Passenger-Side Fender Modification

1. Locate the inner fender cover plate.
2. Using tape, secure the plate to the firewall under the passenger-side fender as shown in Photo 1, below.
NOTE: The plate must sit flat against the firewall completely below the bend line as shown in Photo 1, below.
3. Using the plate as a template, mark the (2) small holes and (2) large holes, then remove the plate (See Photo 2, below). Drill the (2) small holes to 5/32", and the (2) large holes to 1 1/4" (See Photo 3, below).
4. Identify the 1/4" OEM hole on the fender skirt under the battery tray, it is located next to an OEM 3/4" hole (See Photo 4, below). **NOTE: There may be a factory wiring retainer mounted in the hole, you will need to remove it if present (See Photo 4, below).**
5. Enlarge the 1/4" hole to 7/8" and deburr (See Photo 4, below).

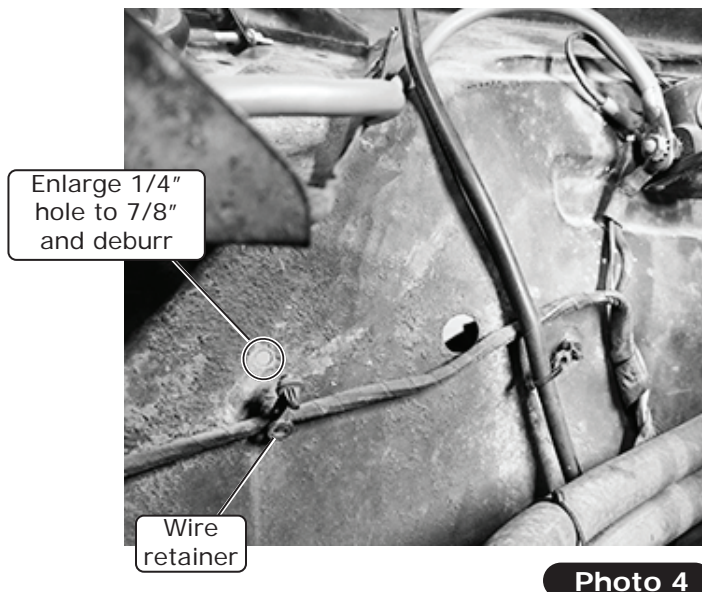
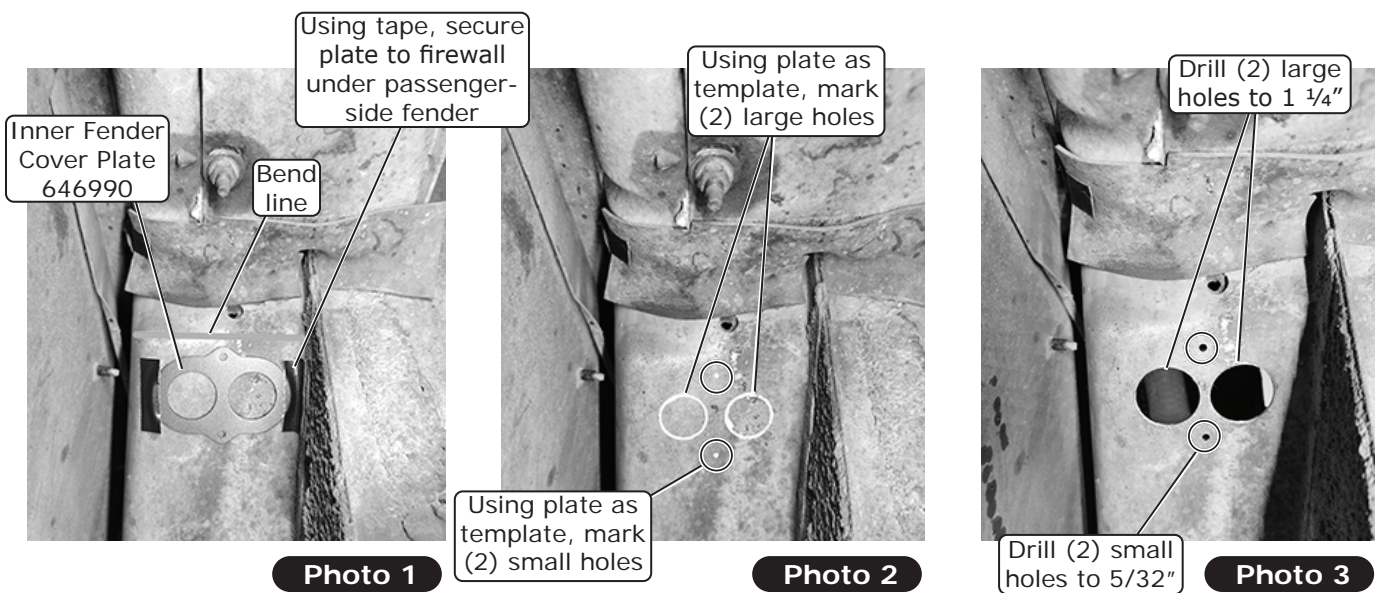



www.vintageair.com

Firewall Insulation

NOTE: For proper operation of the evaporator module, Vintage Air recommends using heat-blocking insulation in the area around the sub case (firewall, inner cowl and kick panel). Due to tight clearance for the evaporator module between the firewall and dash, Vintage Air recommends an insulation thickness of no more than 1/4".

1. Remove the OEM insulation from the area outlined in Photo 1, below. Clean the surface in preparation for the new insulation.
2. Install the new insulation as shown in Photo 2, below. Cover the seams using duct tape.

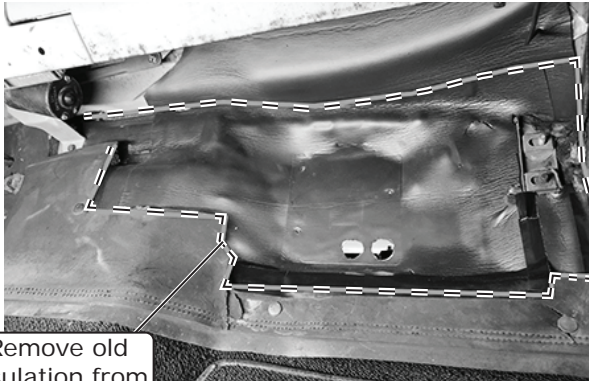

Photo 1

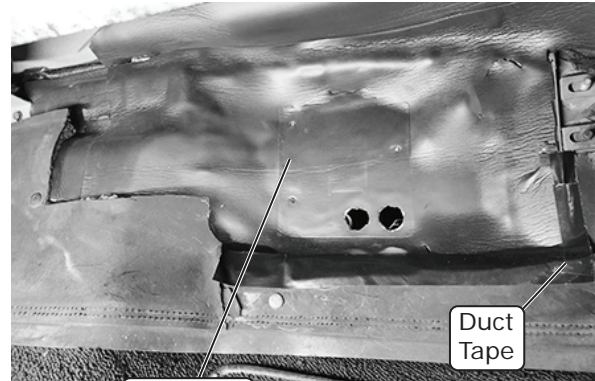

Photo 2

A/C Hose and Kick Panel Cap Installation

Standard Hose Kit:

1. Locate the #6 and #10 A/C hoses. Take both 90° fittings and slide the inner fender cover plate and rubber boot over them as shown in Photo 1, below. **NOTE: The gasket will be a tight fit on the #10 A/C hose. Remove the plug from the fitting to ease installation. Reinstall immediately after.**
2. From under the passenger-side fender well, insert both hoses into the previously drilled holes and feed through the kick panel into the passenger compartment (See Photos 2 and 3, below).

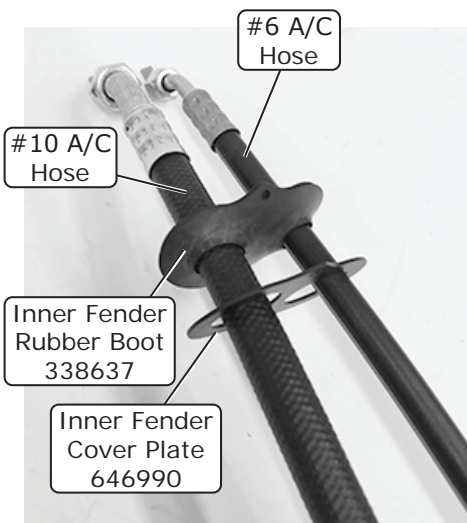

Photo 1

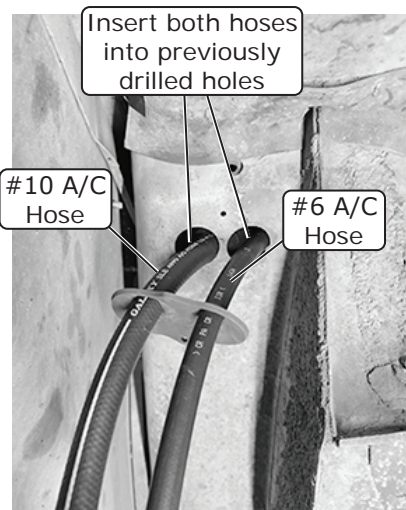

Photo 2

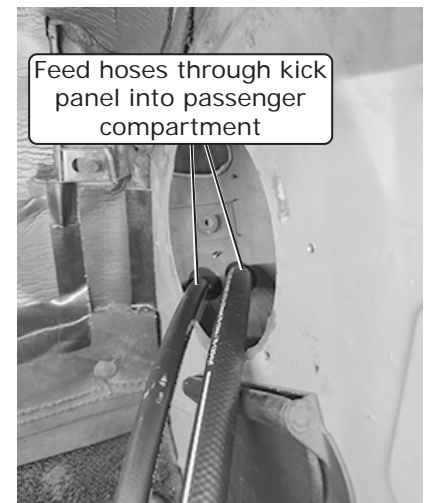

Photo 3



www.vintageair.com

A/C Hose and Kick Panel Cap Installation (Cont.)

3. Once hoses have been ran through the firewall as shown in Photo 4, below, secure the plate and rubber boot to the firewall in the fender well with (2) #10 x 1/2" sheet metal screws into the previously drilled 5/32" holes (See Photo 4, below).
4. From the passenger compartment, loop the #6 A/C hose inside the kick panel and make a 360° turn. Then pull the 45° fitting through the kick panel opening (See Figure 1, below). **NOTE: This is done to prevent kinking of the A/C hoses.**
5. Locate the kick panel cap bracket and insert (2) large grommets into the holes. Route the #6 and #10 A/C hoses through the grommets (See Photo 5, below). **NOTE: For the #10 A/C hose, it is easier to feed the hose into the kick panel cap and then through the grommet.**
6. Apply a 1/2" bead of silicone to the mating surface of the kick panel cap bracket and install it onto the kick panel using (3) OEM screws (See Photo 6, below).

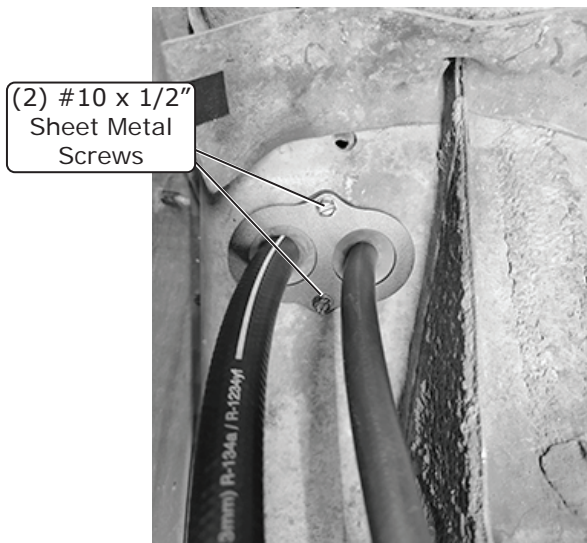

Photo 4

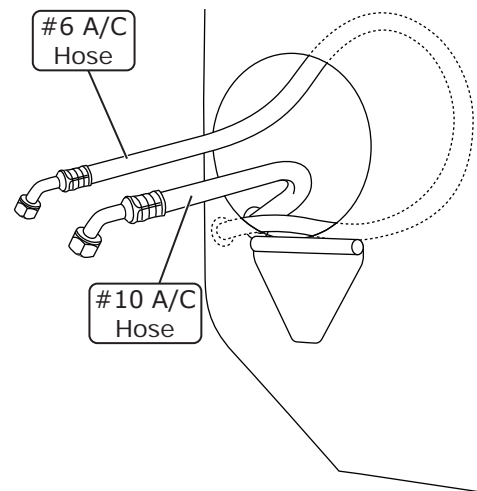

Figure 1

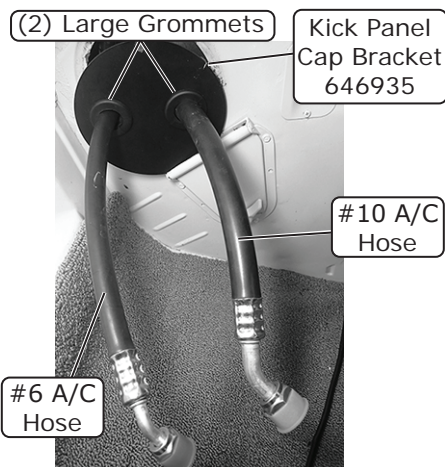

Photo 5

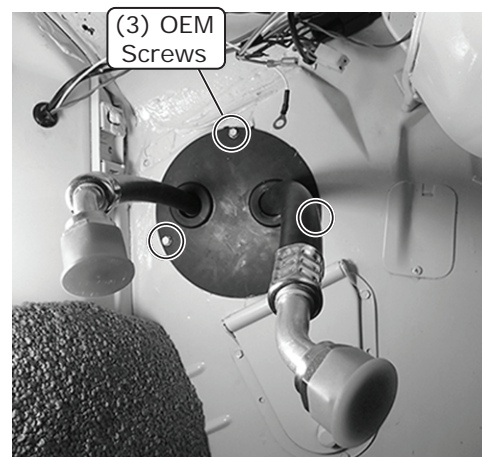

Photo 6



www.vintageair.com

A/C Hose and Kick Panel Cap Installation (Cont.)

7. From under the fender, install the straight end of the #6 A/C hose onto the drier with a properly lubricated #6 O-ring (See Lubricating O-rings, Page 23, and Photo 7, below).
8. Install the bulkhead fitting of the #10 A/C hose into the 7/8" enlarged hole on the inner fender (See Photos 8 and 9, below).

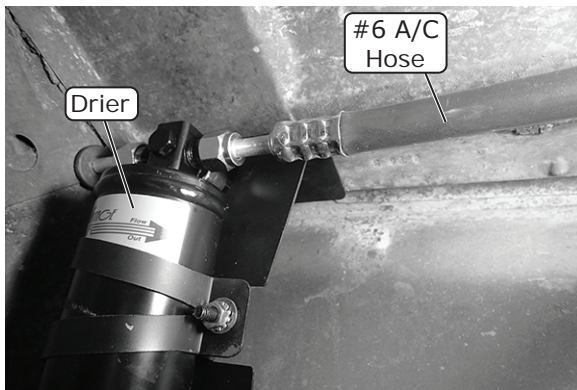

Photo 7

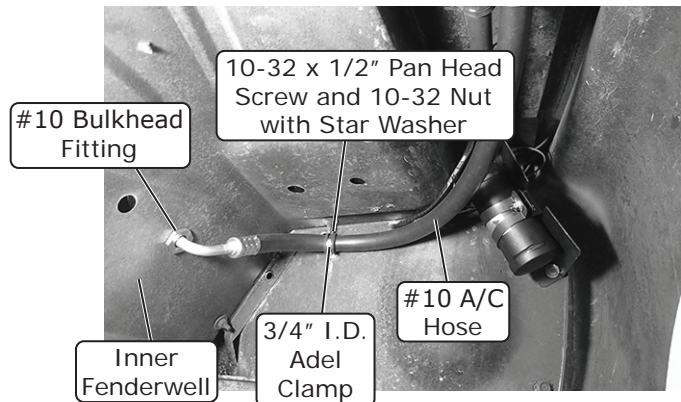

Photo 8

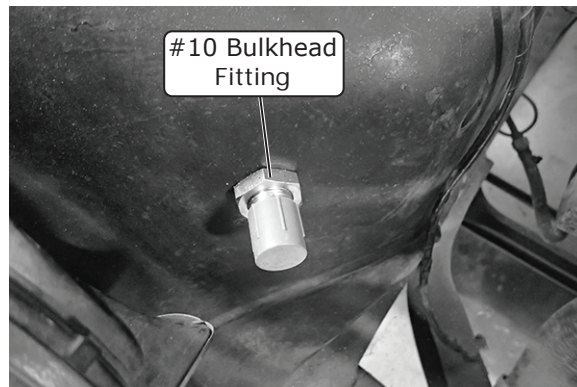

Photo 9



www.vintageair.com

A/C Hose and Kick Panel Cap Installation (Cont.)

- 9. Locate the (2) Adel clamp brackets and install them onto the 3rd and 4th holes under the fender using OEM bolts, washers and nuts (See Photos 10, 11, 12, and Figure 2, below).
- 10. Install (2) 5/8" I.D. Adel clamps and (2) 3/4" I.D. Adel clamps using (2) 10-32 x 1/2" pan head screws and (2) 10-32 nuts with star washers (See Photos 12 and 13, below).

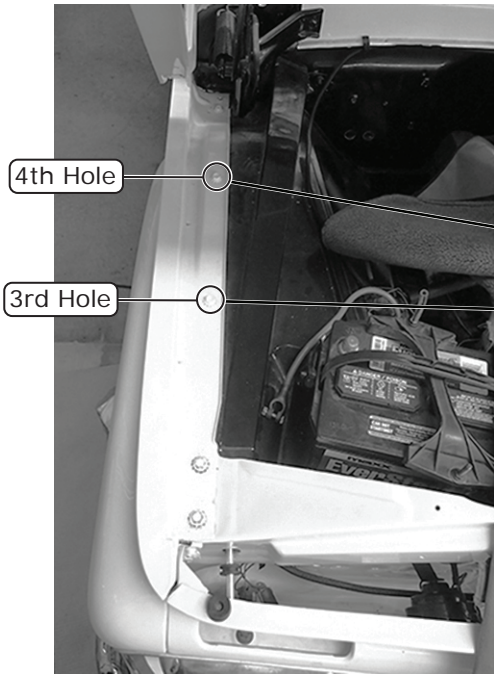

Photo 10

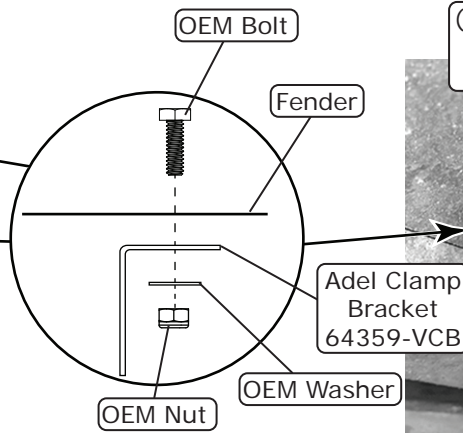

Figure 2

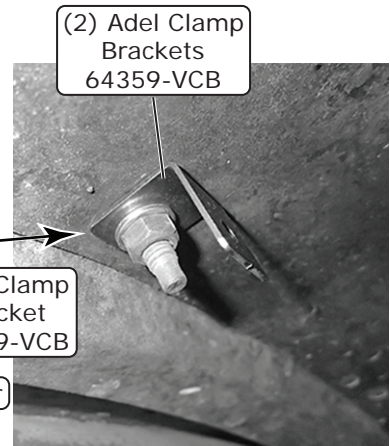

Photo 11

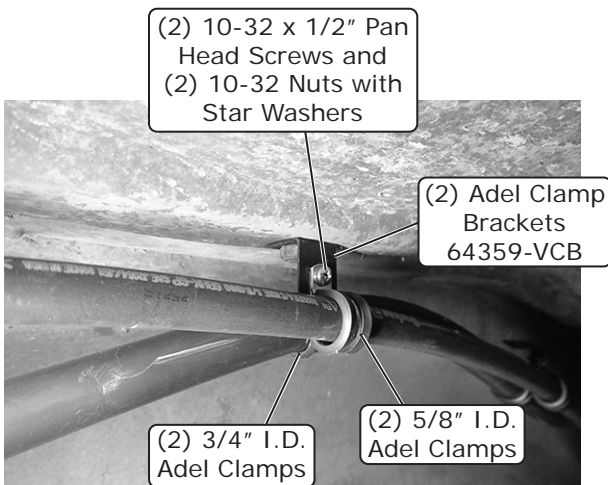

Photo 12

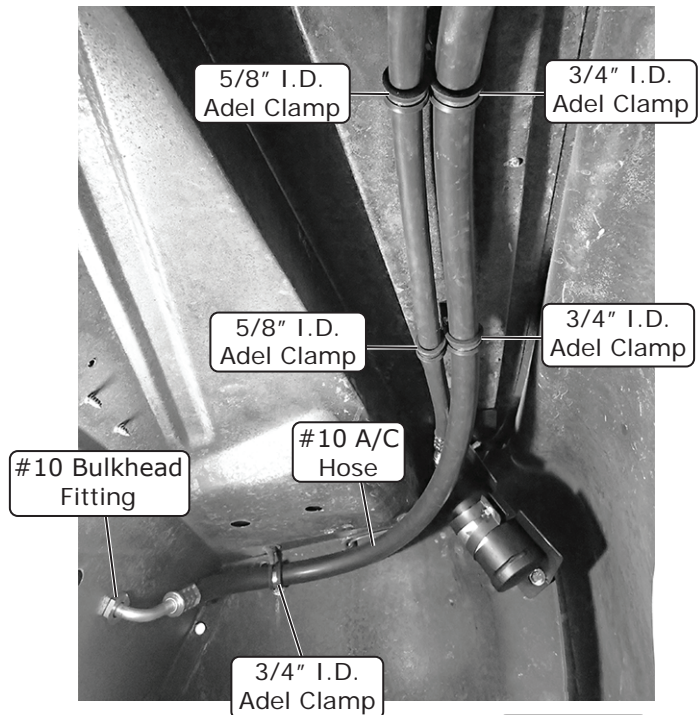

Photo 13



www.vintageair.com

A/C Hose and Kick Panel Cap Installation (Final)

11. Using a 10-32 x 1/2" pan head screw and a 10-32 nut with star washer, install a 3/4" I.D. Adel clamp into the small OEM hole near the #10 bulkhead fitting (See Photo 8, Page 13).
12. Locate the #10 compressor/bulkhead A/C hose. Using (2) properly lubricated #10 O-rings (See Lubricating O-rings, Page 23), install the 135° fitting with service port onto the compressor. Then, install the 90° fitting onto the bulkhead of the other #10 hose (See Photo 16, below).
13. Locate the #8 A/C hose. Using (2) properly lubricated #8 O-rings (See Lubricating O-rings, Page 23), install the 90° fitting with service port onto the compressor. Then, install the 45° fitting onto the #8 hardline attached to the condenser.
14. Use tie wraps to secure the A/C hoses together.

Modified Hose Kit:

1. Refer to separate instructions included with modified hose kit.

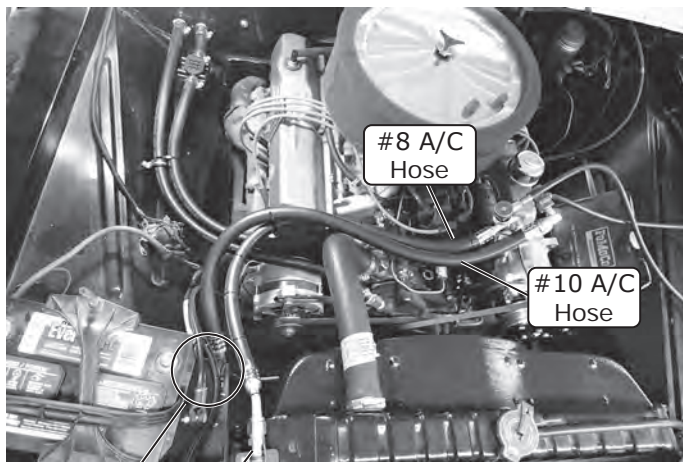

V8 Configuration Photo 14

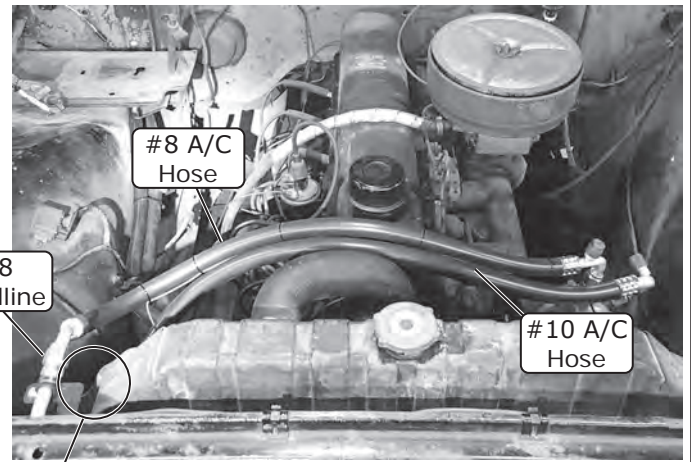

6-Cylinder Configuration Photo 15

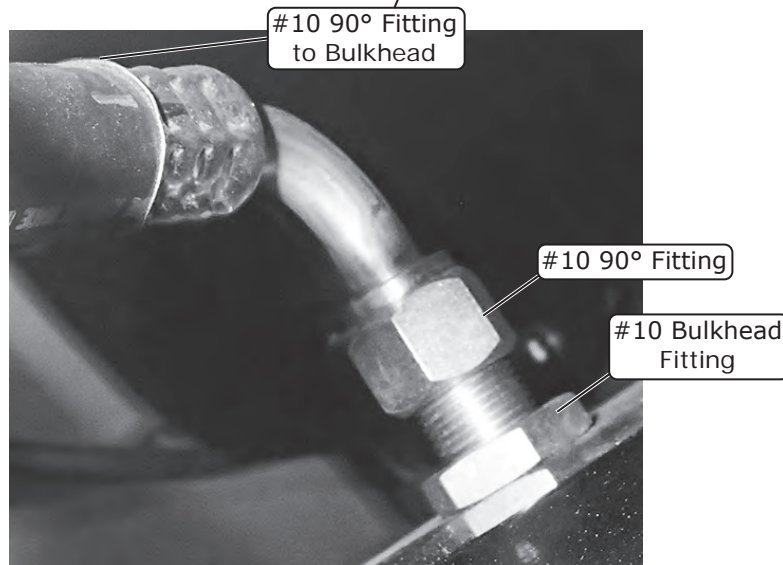

Photo 16



www.vintageair.com

Evaporator Bracket and Hardline Installation

1. On a workbench, install the plenums onto the evaporator module using the supplied spring clips as follows.
2. On the floor plenum, install (2) spring clips onto the back of the evaporator module (See Photos 1 and 2, below).
3. On the defrost plenum, install (2) spring clips onto the front of the evaporator module (See Photo 3, below).
4. On the dash plenum, install (4) spring clips ((2) per side of plenum), onto the side of the evaporator module (See Photo 4, below).
5. Locate and install (3) plastic plugs into the front of the evaporator module as shown in Photos 5 and 6, below.

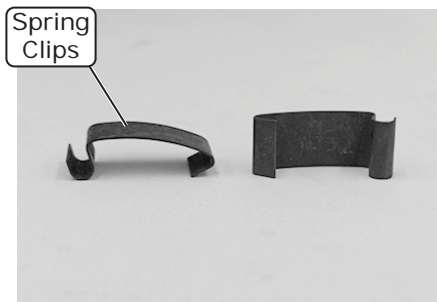

Photo 1

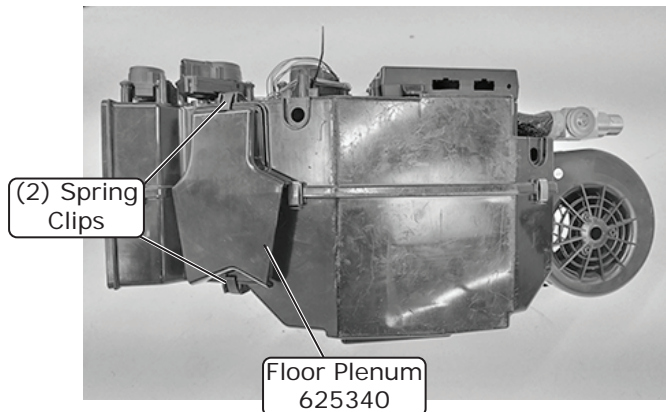

Photo 2

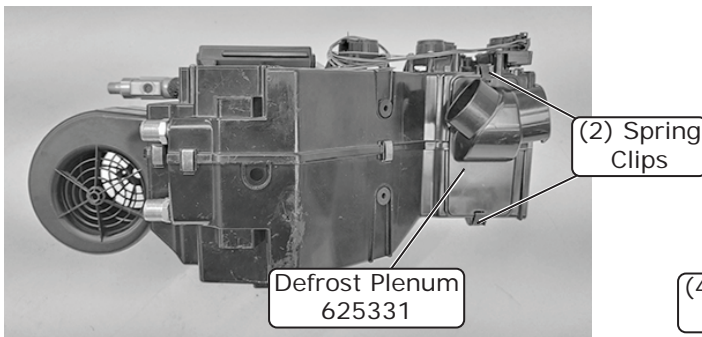

Photo 3

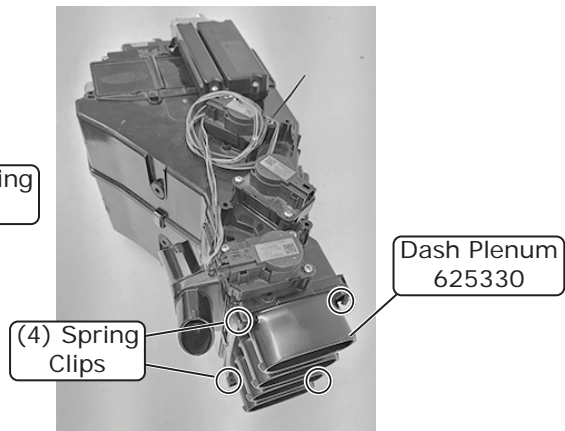

Photo 4

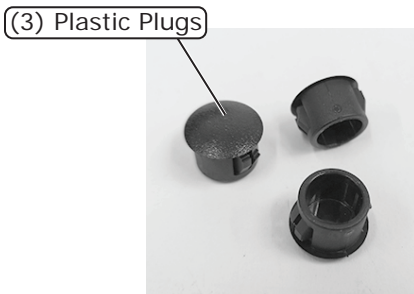

Photo 5

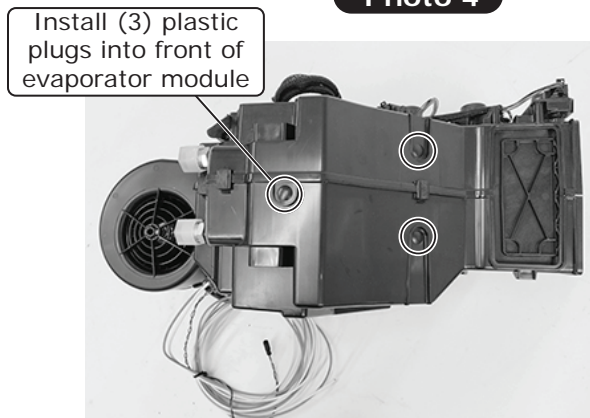

Photo 6



www.vintageair.com

Evaporator Bracket and Hardline Installation (Cont.)

6. Install the evaporator front bracket onto the front of the module using (4) #10 x 5/8" screws, (2) screws on the top and (2) screws on the bottom of the bracket, as shown in Photos 7 and 8, below.
7. Apply (2) strips of double-sided transfer tape onto the front bracket as shown in Photo 9, below. **NOTE: This will secure the gasket in place during the installation.**
8. Install (2) heater hardlines with properly lubricated #10 O-rings (See Lubricating O-rings, Page 23). Using a 1 1/16" wrench, or wrench provided with the condenser kit, and a backing wrench on the evaporator module fittings, center the heater lines into the corresponding holes on the bracket and tighten (See Photo 10, below).
9. Place the firewall rubber boot over the front bracket and the (2) heater line ends (See Photo 11, below). Ensure the lines are tight and remain centered inside the bracket holes. Ensure all the mounting holes on the bracket align with the corresponding holes on the rubber boot (See Photo 11, below). **NOTE: It will be a tight fit, remove the heater line caps before installing the rubber boot then immediately replace them once the rubber boot is installed.**

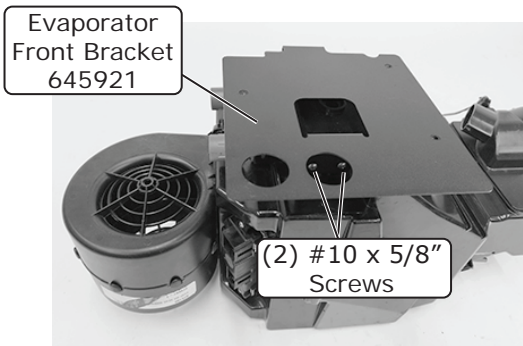

Photo 7

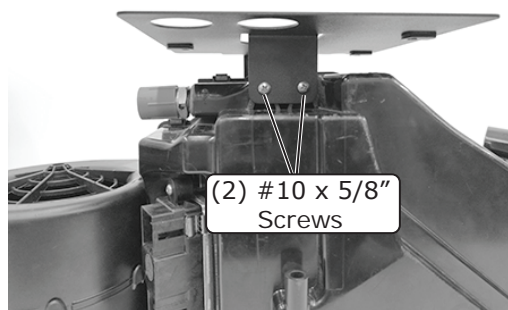

Photo 8

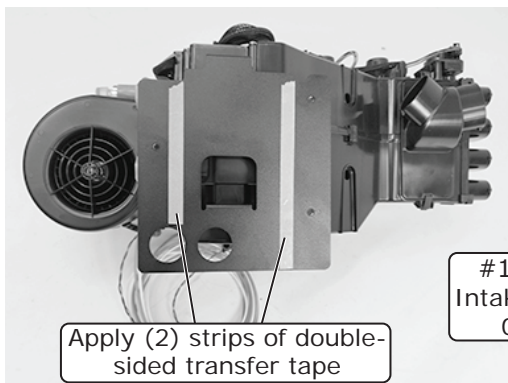

Photo 9

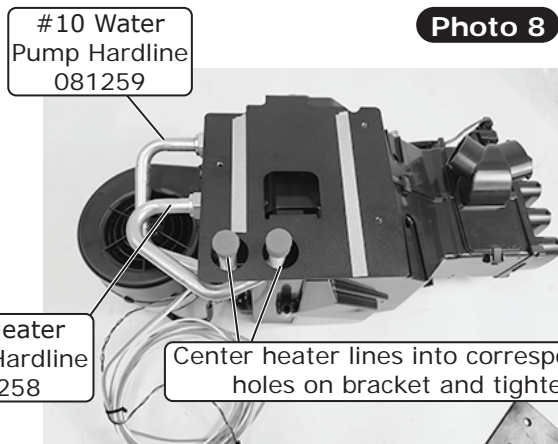

Photo 10

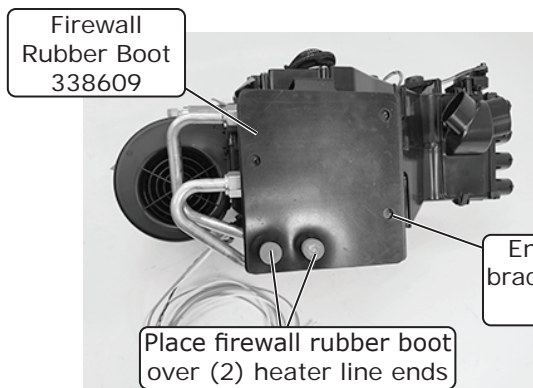

Photo 11



www.vintageair.com

Wiring Harness Installation

1. From the front passenger fender well, locate a small OEM hole on the firewall next to the A/C line holes (See Photo 1, below). Enlarge the hole to 5/8" to accommodate the 3/8" O.D. x 1/2" I.D. grommet provided.
NOTE: Some vehicles may not have this OEM hole, in this case a hole will need to be drilled in this location.
2. Route the heater control valve plug through the 3/8" O.D. x 1/2" I.D. grommet then install the grommet into the previously enlarged hole (See Photos 2 and 3, below).
3. Route the red, blue, and white wires through grommet (See Photo 4, below).
4. Attach the white ground wire with ring terminal to a suitable ground and attach to the kick panel near the firewall (See Photo 5, below).
5. Mount the main harness relay where it will not interfere with the evaporator installation (See Photo 6, below).

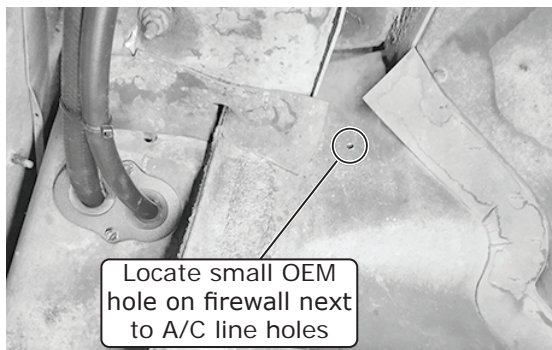

Photo 1

Route heater control valve plug through 3/8" O.D. x 1/2" I.D. grommet

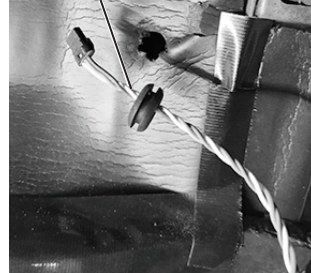

Photo 2

Install grommet into previously enlarged hole

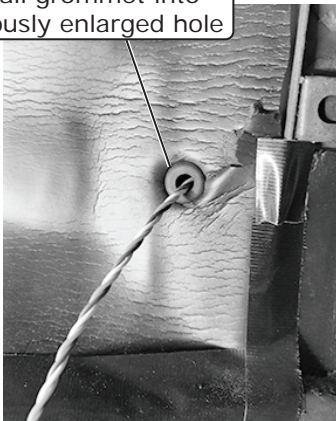

Photo 3

Route red, blue and white wires through grommet



Photo 4

Attach white ground wire with ring terminal to suitable ground

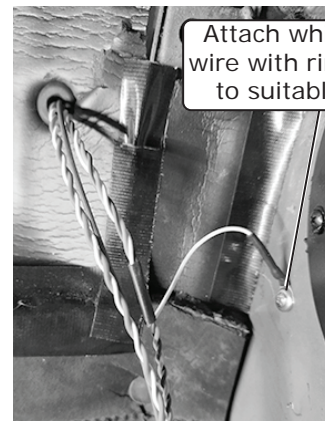

Photo 5

Mount main harness relay where it will not interfere with evaporator installation

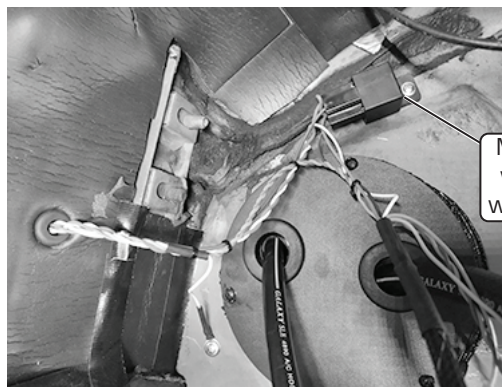

Photo 6



www.vintageair.com

Wiring Harness Installation (Cont.)

6. Bring the evaporator onto the passenger floorboard. Run the heavy gauge orange and white wires through the grommet along the other wires (See Photos 7 and 8, below).
7. From the passenger fender well, feed the heater control valve plug between the fender and firewall up into the engine compartment (See Photos 9 and 10, below). **NOTE: Wire loom should be used to prevent chafing.**
8. Apply the provided wire loom to the remaining blue, orange, red and white wires, and route along the A/C lines toward the front of the vehicle (See Photo 11, below). Secure with tie wraps. **NOTE: The blue wire should not be completely loomed, it will need to be removed from the loom before reaching the drier to be connected to the binary switch (See Photo 12, below).**

Bring evaporator onto passenger floorboard

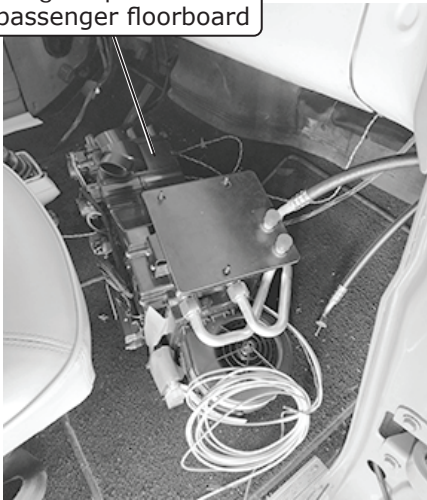

Photo 7

Run heavy gauge orange and white wires through grommet

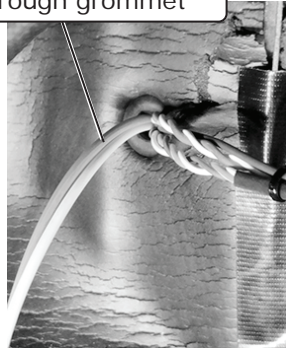

Photo 8

Feed heater control valve plug between fender and firewall up into engine compartment



Photo 9

Feed heater control valve plug between fender and firewall up into engine compartment

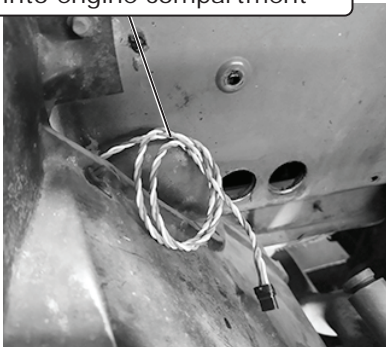
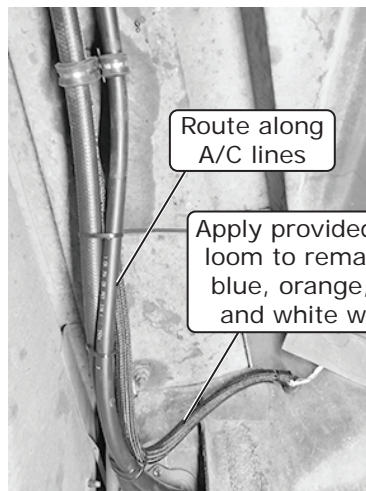

Photo 10

Route along A/C lines



Apply provided wire loom to remaining blue, orange, red and white wires

Photo 11

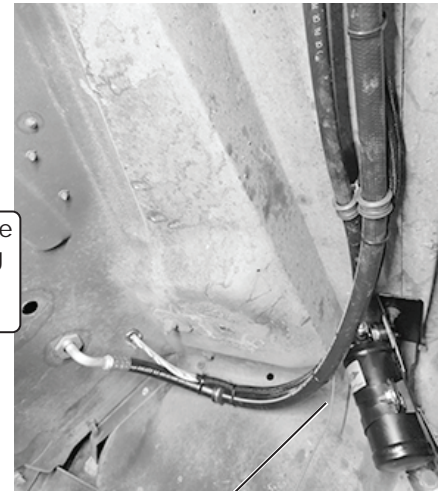

Blue wire should not be completely loomed

Photo 12



www.vintageair.com

Wiring Harness Installation (Final)

9. Drill a 5/8" hole under the battery tray near the bulkhead to accommodate the 3/8" O.D. x 1/2" I.D. grommet. Install the grommet and run the wires through it into the engine bay (See Photo 13, below).
10. Route the blue wire to the binary switch on the drier. Trim to length and terminate with the spade connector. Connect the wire to the binary switch (See Photo 14, below). **NOTE: Loom and secure the wire to prevent chafing.**

5/8" hole with 3/8" O.D. x 1/2" I.D. grommet

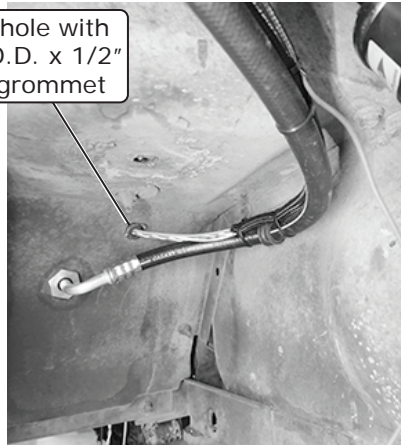

Photo 13

Connect blue wire to binary switch, loom and secure



Photo 14

Evaporator Installation

1. Locate the (3) 1/4-20 full-threaded studs (See Photo 1, below). With the evaporator module on the passenger floorboard install the studs onto the firewall rubber boot and the evaporator front bracket assembly as shown in Photo 2, below.
2. Locate the provided duct hose. Cut two separate lengths, 18" and 28" long. Install the 18" length of duct hose onto the passenger-side of the defrost plenum on the evaporator module, and the 28" length onto the driver-side of the defrost plenum. Secure both with tie wraps as shown in Photo 3, below.

(3) 1/4-20 Full-Threaded Studs



Photo 1

Install studs onto firewall rubber boot and evaporator front bracket assembly

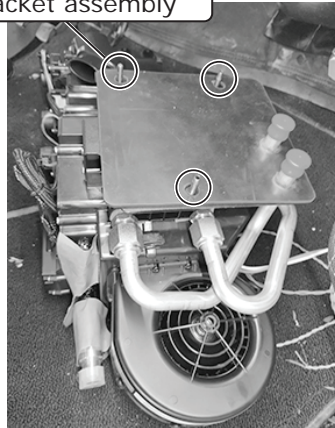

Photo 2

Install 18" length of duct hose onto passenger-side of defrost plenum

Install 28" length of duct hose onto driver-side of defrost plenum

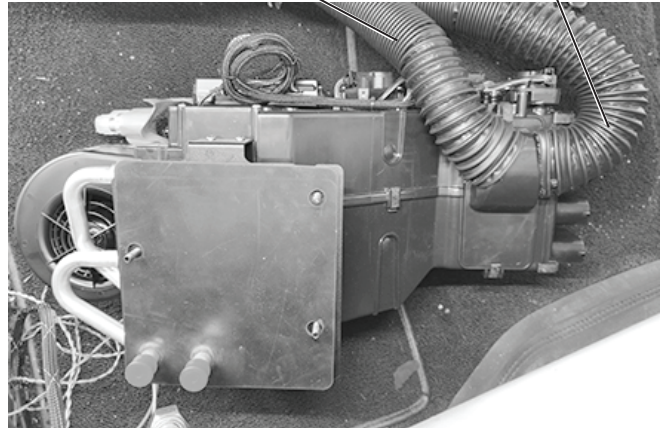

Photo 3



www.vintageair.com

Evaporator Installation (Cont.)

3. Carefully install the evaporator module into the passenger compartment, keeping the installed duct hoses routed over the module toward the dashboard to avoid interference during the installation (See Photos 4 and 5, below).
4. Once the evaporator is in place with the heater hardlines, and all (3) studs are going through the firewall, support the module using a block or have a second person help. From the engine bay, remove and replace each stud one at a time with (3) 1/4-20 x 3/4" black serrated flange bolts (See Photo 6, below).
5. From inside the cab, locate (2) 1/4-20 well nuts and install them into the evaporator module through the glove box (See Photo 7, below).
6. Install the evaporator rear bracket through the glove box and secure it to the well nuts using (2) 1/4-20 x 1" serrated flange bolts and (2) 1/4" USS flat washers (See Photo 8, below). Leave loose.

Install evaporator module into passenger compartment

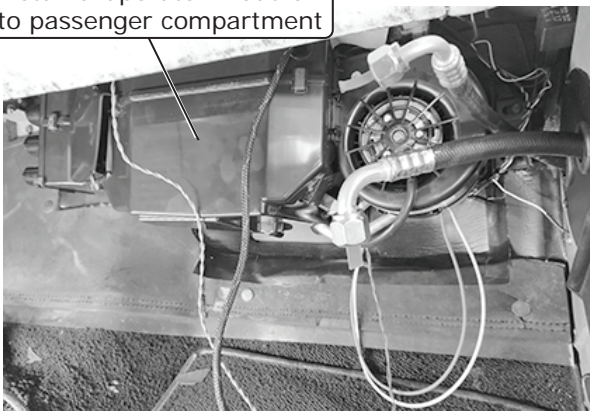

Photo 4

Keep duct hoses routed over module towards dashboard

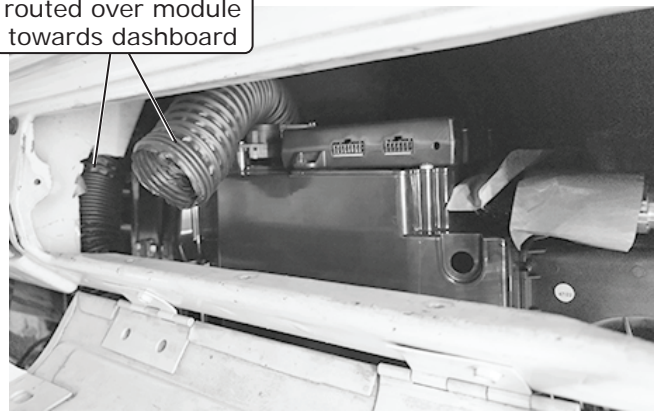

Photo 5

Remove and replace each stud one at a time with (3) 1/4-20 x 3/4" black serrated flange bolts

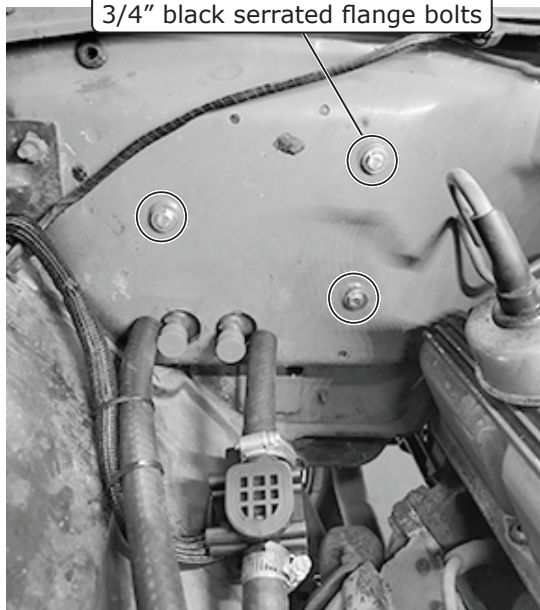

Photo 6

(2) 1/4-20 Well Nuts

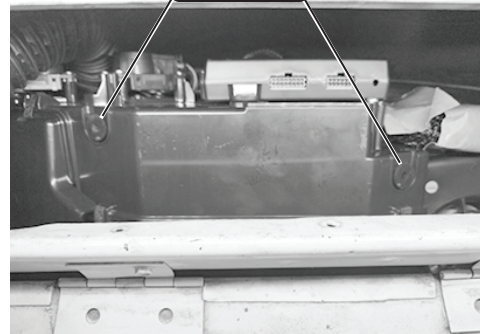
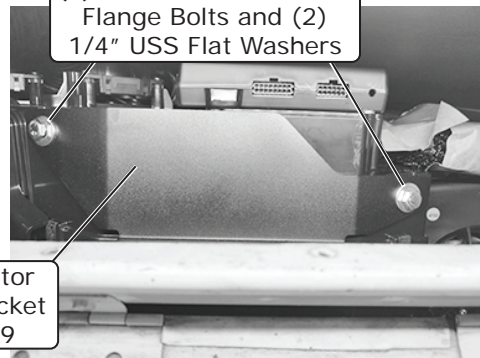

Photo 7

(2) 1/4-20 x 1" Serrated Flange Bolts and (2) 1/4" USS Flat Washers



Evaporator Rear Bracket 645919

Photo 8



www.vintageair.com

Evaporator Installation (Final)

7. Secure the evaporator rear bracket to the dashboard using (2) 10-32 x 1/2" pan head screws, (2) 1/4" USS flat washers on the outside, (2) 1/4" USS flat washers on the inside, and (2) 10-32 nuts with star washers (See Photos 9, 10 and 11, below).
8. Tighten all mounting hardware.
9. From the engine bay, connect the heater hoses to the hardlines and secure with hose clamps (See Photo 12, below). **NOTE: To reduce stress on the hardlines during the hose installation, lubricate the lines with soapy water and if possible have a second person hold the hardlines in place from inside of the cab. Photo taken from a 1965 F-100 for reference only, heater line orientation may differ.**
10. With properly lubricated O-rings (See Lubricating O-rings, Page 23), connect the #10 and #6 A/C hoses to the evaporator module as shown in Photos 13 and 14, below. **NOTE: Connect the #6 A/C hose first.**
11. Apply press tape to the #10 fitting (See Photo 15, below).

1/4" USS Flat Washer

10-32 x 1/2" Pan Head Screw

(2) 1/4-20 x 1" Serrated Flange Bolts and (2) 1/4" USS Flat Washers

(2) 1/4" USS Flat Washers and (2) 10-32 Nuts with Star Washers

10-32 Nut with Star Washer

Photo 9

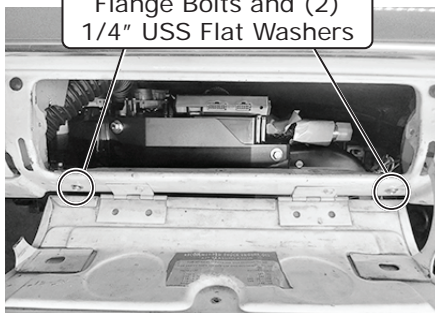
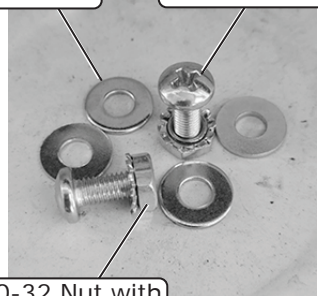

Photo 10

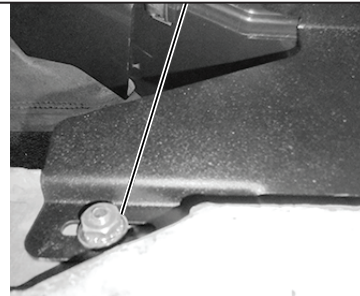

Photo 11

Connect heater hoses to hardlines and secure with hose clamps



Photo 12

Connect #6 A/C hose to evaporator

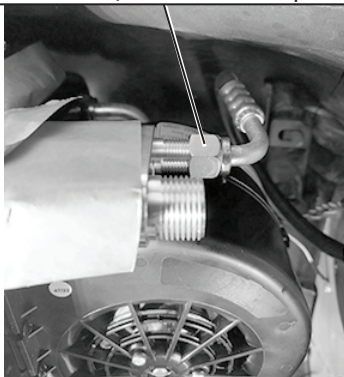

Photo 13

Connect #10 A/C hose to evaporator

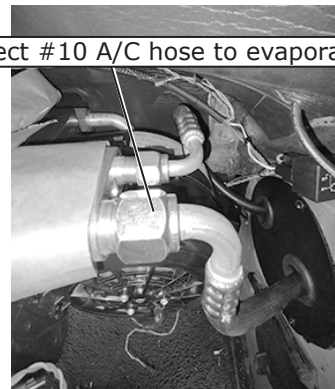

Photo 14

Apply press tape to #10 fitting

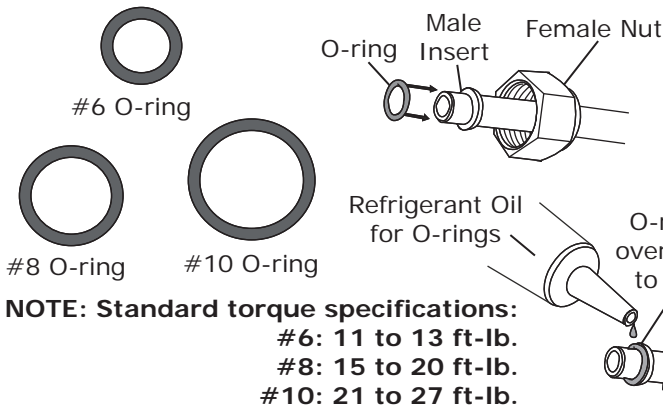

Photo 15



www.vintageair.com

Lubricating O-rings



For a proper seal of fittings: Install supplied O-rings as shown and lubricate with refrigerant oil.

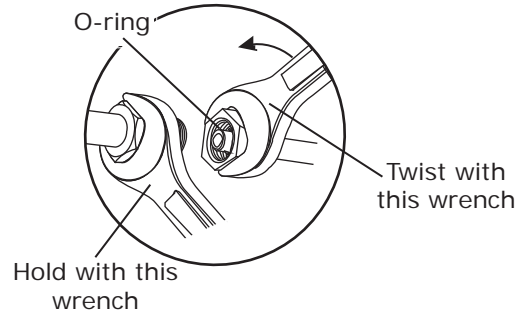

Properly Seated O-ring Land

When installing a hardline or A/C hose fitting onto the evaporator module, ensure the O-ring land is seated properly (See Photo 1, below). An improperly seated O-ring land (See Photo 2, below) can cause a leak. To properly install the fitting, slide the hardline or A/C hose nut back to expose the O-ring land and seat it onto the evaporator module fitting. Then, slide the hardline or A/C hose nut forward and thread it onto the evaporator module fitting, ensuring the O-ring land does not move or lift.

Properly Seated O-ring Land



Photo 1

Improperly Seated O-ring Land

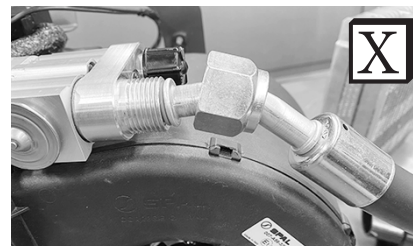

Photo 2

NOTE: Photos shown are for reference only. Fittings may vary depending on kit received.



www.vintageair.com

Drain Hose Installation

1. Locate the evaporator drain on the bottom of the evaporator case (See Figure 1, below).
2. In line with the drain, lightly make a mark on the firewall. Measure 1" down and drill a 5/8" hole through the firewall (See Figure 1, below).
3. Install the drain hose onto the evaporator drain on the bottom of the module, and route through the firewall (See Figure 1, below).
4. On the engine compartment side of the firewall, measure and cut the drain hose 1 1/2" from the firewall. Install a 90° elbow onto the drain hose and attach another piece of drain hose to the other end (See Figure 1a, below).

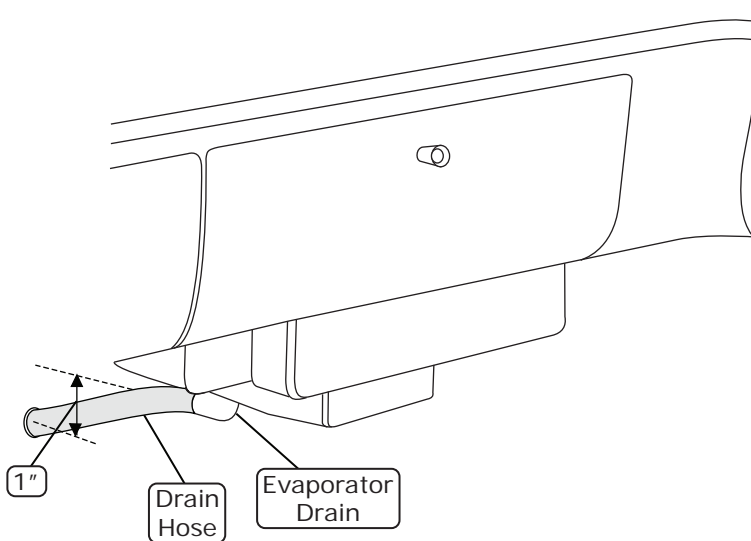

Figure 1

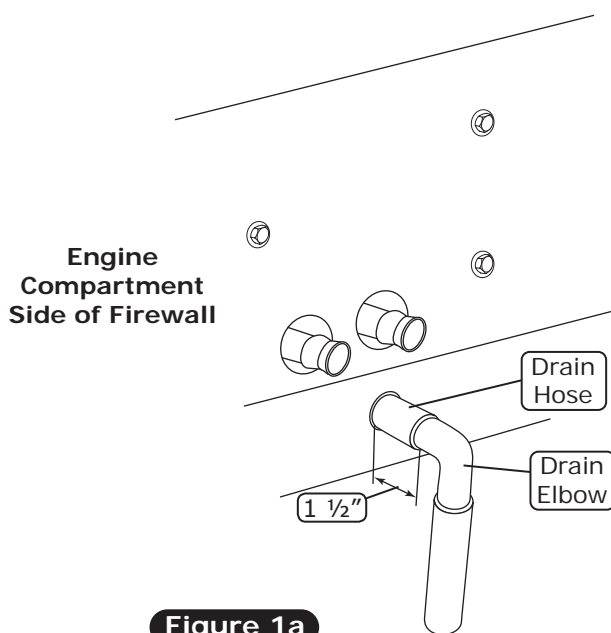

Figure 1a



www.vintageair.com

Heater Hose and Heater Control Valve Installation

1. Route a piece of 5/8" heater hose from the water pump to the left heater line hole on the firewall, and secure to the water pump with a hose clamp (See Photos 1 and 2, below).
 2. Cut a 5" piece of 5/8" heater hose and attach it to the outlet side of the heater control valve. This will connect to the right heater line coming through the firewall (See Photo 1, below).
 3. Connect a length of 5/8" heater hose to the inlet side of the heater control valve and route it from the valve to the intake manifold as shown in Photos 1 and 2, and Figure 1, below. Secure with a hose clamp.
- NOTE: Ensure proper flow direction through the heater control valve (the flow direction follows the molded arrow on the valve).**
4. Connect the heater control valve plug from the main wiring harness to the valve, then loom and secure the wires (See Photos 3 and 4, below).

Route piece of 5/8" heater hose from water pump to left heater line hole on firewall

Cut 5" piece of heater hose and attach it to outlet side of heater control valve, this will connect to right heater line coming through firewall

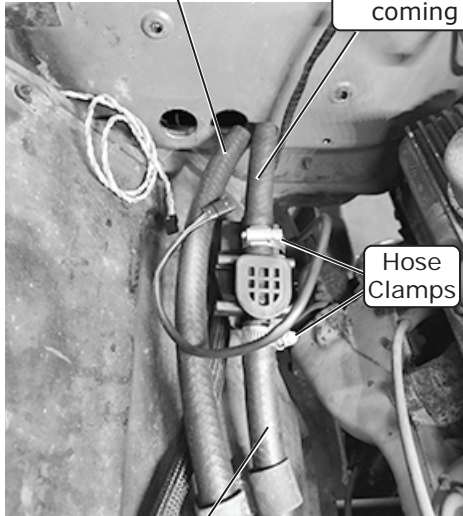
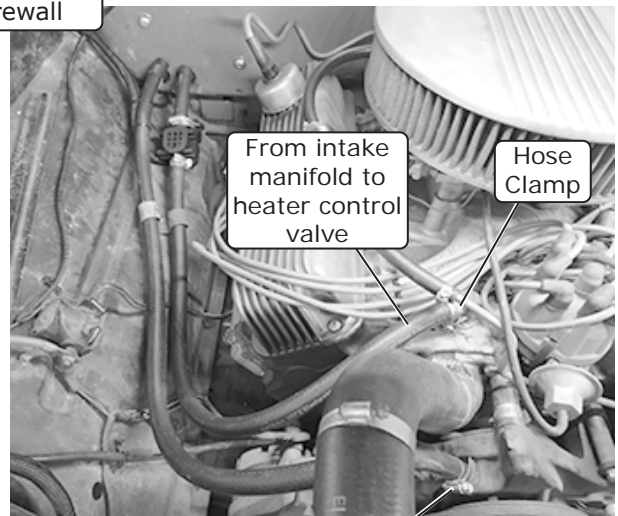

Photo 1



From intake manifold to heater control valve

Hose Clamp

Hose Clamp

Photo 2

Connect 5/8" heater hose to inlet side of heater control valve and route it from valve to intake manifold

Connect heater control valve plug from main wiring harness to valve

Loom and secure wires

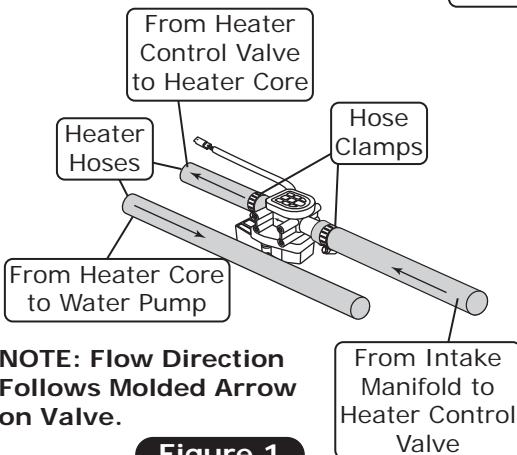

NOTE: Flow Direction Follows Molded Arrow on Valve.

Figure 1

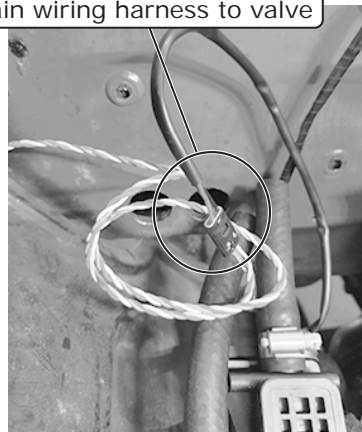

Photo 3

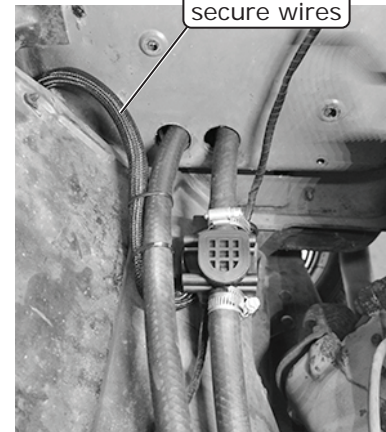

Photo 4



www.vintageair.com

A/C and Heater Hose Routing

NOTE: Vintage Air Systems use 5/8" heater connections. On engines equipped with 3/4" hose nipples, these will need to be removed and replaced with 5/8" nipples (not supplied). For water pumps with a cast-in 3/4" heater outlet, a 3/4" x 5/8" reducer fitting (not supplied) will need to be installed in the heater hose.

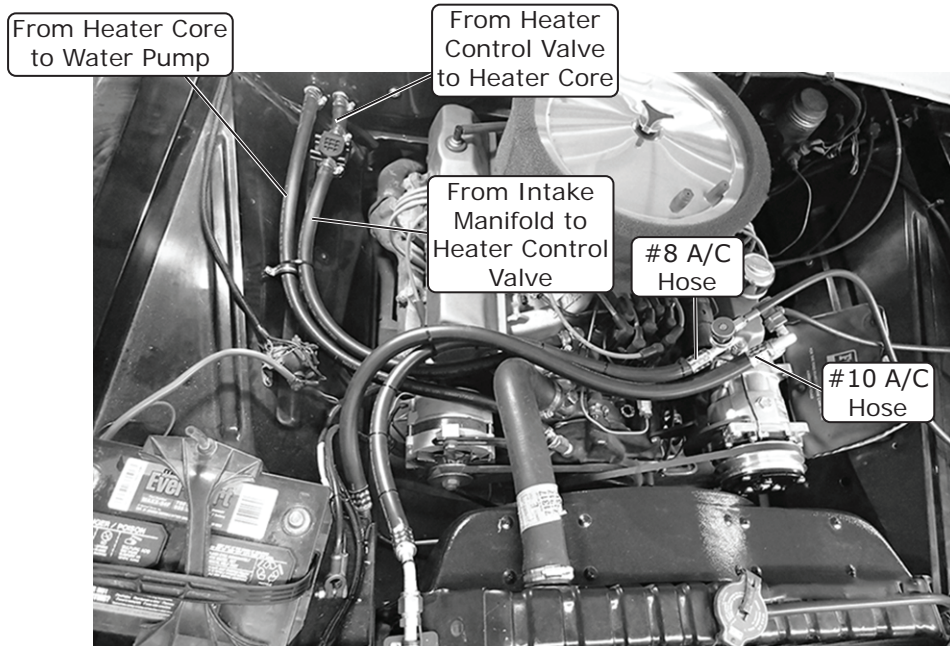

Photo 1

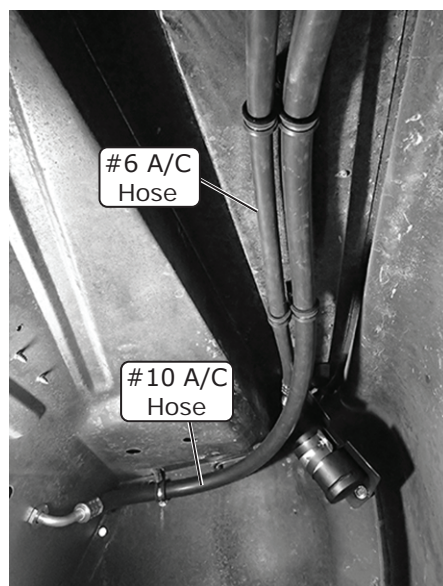

Photo 2



www.vintageair.com

Passenger-Side Louver Installation

1. Locate the passenger-side louver bezel, cap and bracket. Insert the bracket into the bezel as shown in Photo 2, below. Place the louver assembly against the passenger-side kick panel in front of the evaporator fan, with the top front edge of the louver bezel against the bottom edge of the dash as shown in Photos 1 and 5, below.
2. Once the louver is in the desired location and position, mark the (2) holes from the louver bracket onto the kick panel. Remove the louver assembly and drill (2) 5/32" holes into the kick panel (See Photos 2 and 3, below).
3. Install a length of 2 1/2" duct hose onto the hose adapter at the top of the louver. Install the louver assembly onto the kick panel using (2) #10 x 3/4" sheet metal screws (See Photo 4, below). **NOTE: Refer to Duct Hose Routing, Page 37, for duct hose lengths.**
4. Install the louver into the louver opening in the bezel (See Photo 5, below).
5. Install the louver cap from the bottom of the louver assembly, and secure using (3) #6 x 3/8" pan head screws (See Photo 6, below).



Photo 1

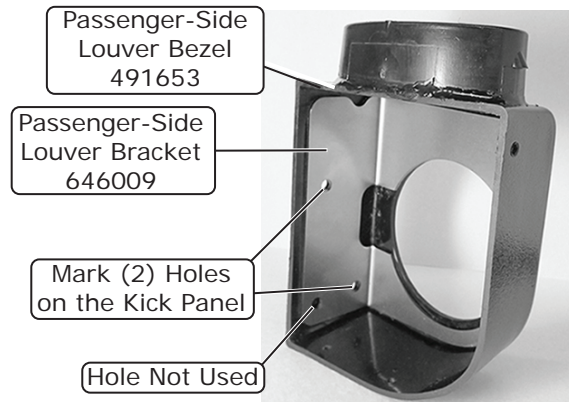

Photo 2

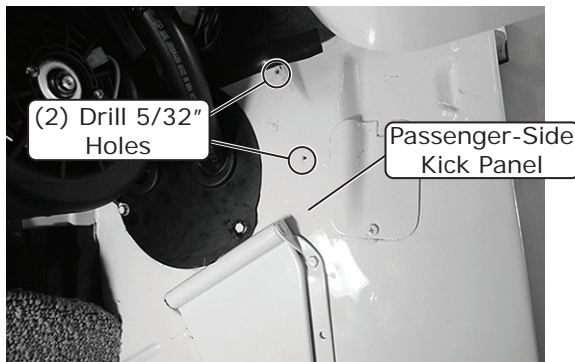

Photo 3

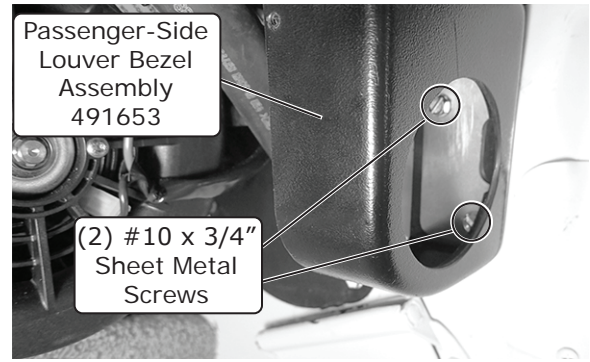

Photo 4

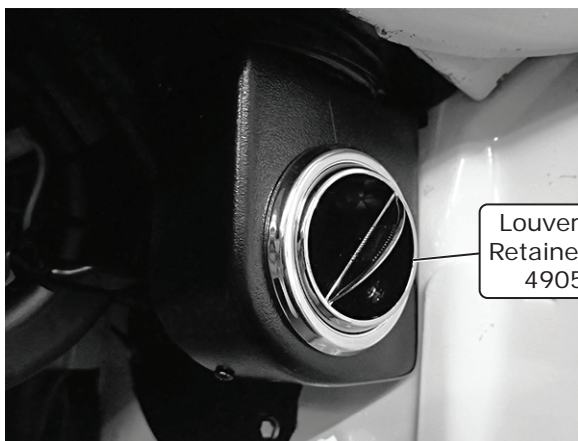

Photo 5

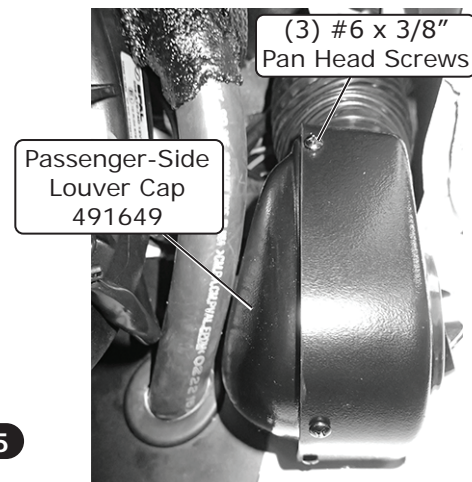

Photo 6



www.vintageair.com

Driver-Side Louver Installation

1. Locate the driver-side louver bezel and bracket. Insert the bracket into the louver bezel (See Photo 1, below). Place the louver assembly against the driver-side kick panel, and position the same as the passenger side.
2. Once the louver is in the desired location and position, mark the (2) holes from the bracket onto the kick panel. Remove the louver assembly and drill (2) 5/32" holes (See Photos 1, 2 and 3, below).
3. Install the louver assembly using (2) #10 x 3/4" sheet metal screws (See Photo 4, below). Install the louver into the louver opening (See Photo 5, below). Install a length of 2 1/2" duct hose onto the hose adapter on the back of the louver assembly. **NOTE: Refer to Duct Hose Routing, Page 37, for duct hose lengths.**

Driver-Side Louver Bezel
491647

Driver-Side Louver Bracket
646008

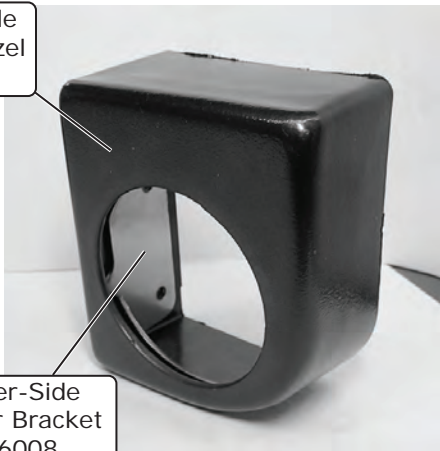

Photo 1

Mark (2) Holes
on the Kick Panel

Either Hole
May Be Used

Hole Not Used

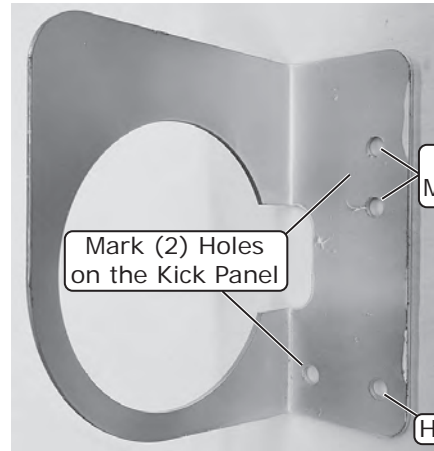

Photo 2

Driver-Side Kick Panel

(2) Drill 5/32"
Holes

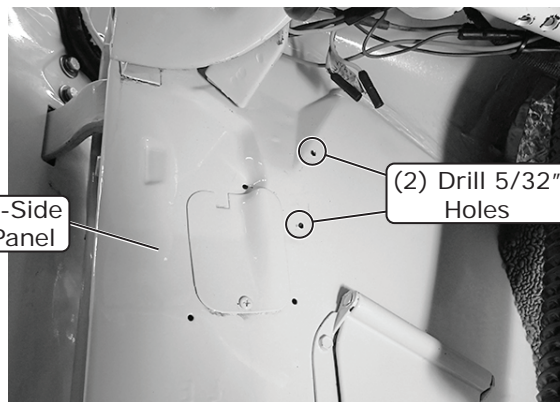

Photo 3

(2) #10 x 3/4"
Sheet Metal
Screws

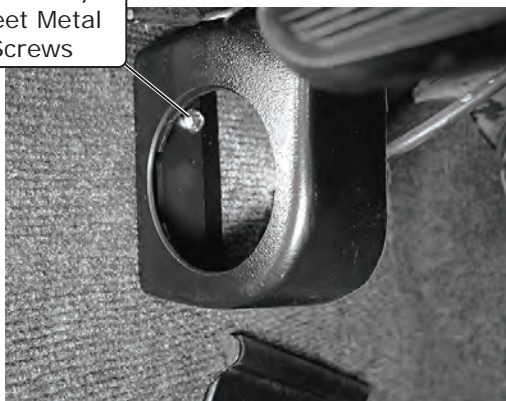

Photo 4

Louver with
Hose Adapter
490531

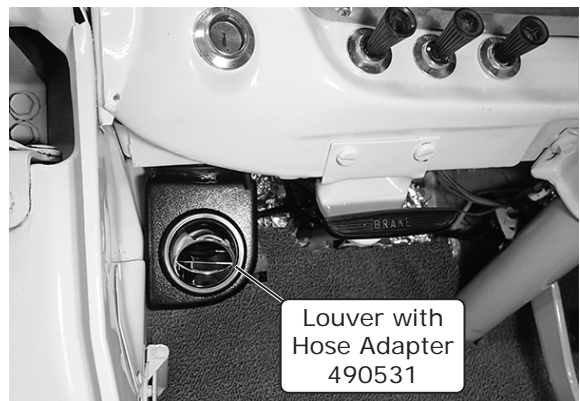

Photo 5



www.vintageair.com

Center Louver and Control Panel Installation

1. Locate the control panel template bracket and the center louver bezel. Place the template into the bezel with the small holes toward the bottom of the louver, and slide the bracket all the way to the end. Secure the bracket using clamps or a vise grip. **NOTE: Protect the front of the bezel where the clamps are attached to avoid scratching the plastic.** Using the bracket as a template, drill (3) 19/64" and (3) 5/32" holes (See Photo 1, below).
2. Install the (3) labels as shown in Photo 2, below.
3. Install the (3) rotary pot assemblies into the back side of the bracket/template. Insert the notch of the rotary pot into the small hole and secure it into the louver and bracket using the washer and nut provided on each control (See Photos 3 and 4, below).
4. Install the wiring harness onto the rotary pot assemblies and secure using (5) small tie wraps as shown in Figure 1, below.

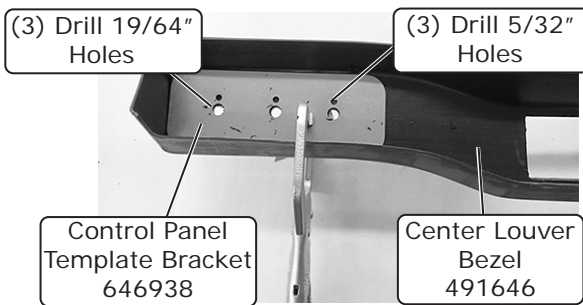

Photo 1

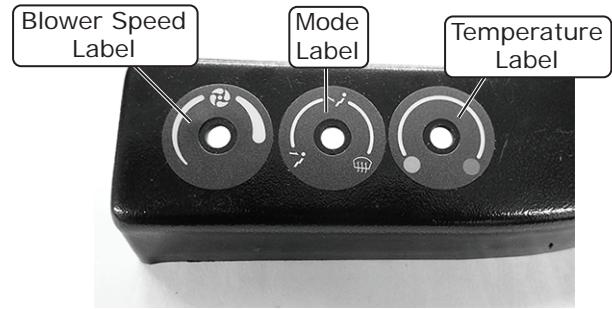

Photo 2

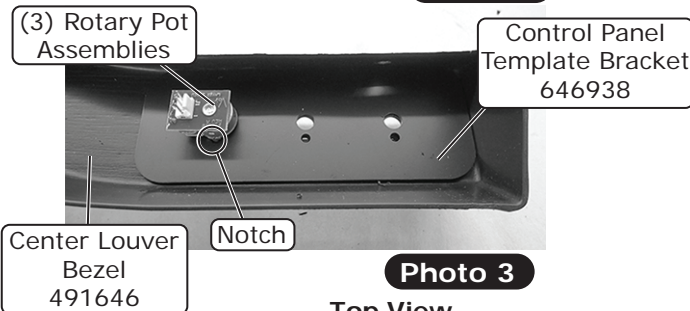

Photo 3

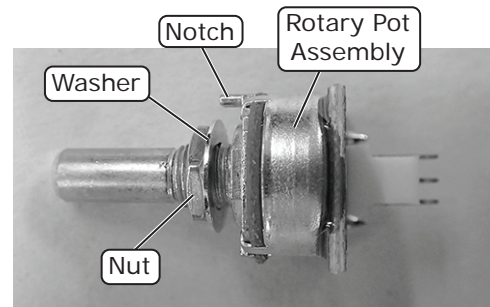

Photo 4

Top View

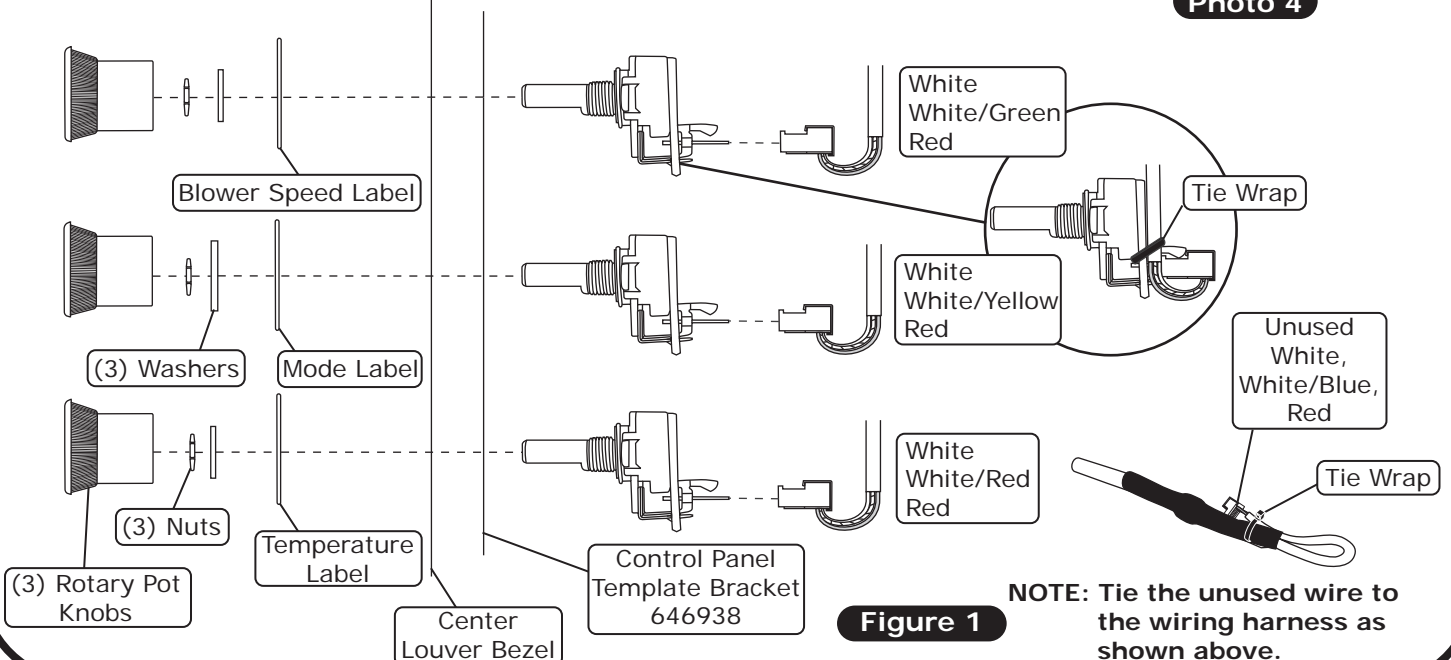

Figure 1

NOTE: Tie the unused wire to the wiring harness as shown above.



www.vintageair.com

Center Louver and Control Panel Installation (Cont.)

5. Install the (3) control knobs (See Photo 5, below).
6. Install the center louver assembly under the dash using the OEM holes and (4) 1/4-20 x 3/4" hex bolts, (8) 1/4" USS flat washers and (4) 1/4-20 hex nuts with star washers (See Photo 6 and Figure 2, below). **NOTE: If the dash does not have all of the OEM holes, use the louver bezel as a template to mark and drill 5/16" holes to install the necessary hardware. OEM dash stamped holes may vary, in some cases you may need to enlarge some mounting holes onto the new under dash louver bezel to align it following the OEM dash contour.**
7. Insert (2) lengths of 2 1/2" duct hose through the center louver openings, and install onto (2) 4 3/4" x 1 1/2" with 2 1/2" hose adapter louvers. Push the center louver vents in to secure them into the center louver bezel (See Photos 7 and 8, below). **NOTE: Refer to Duct Hose Routing, Page 37, for duct hose lengths.**

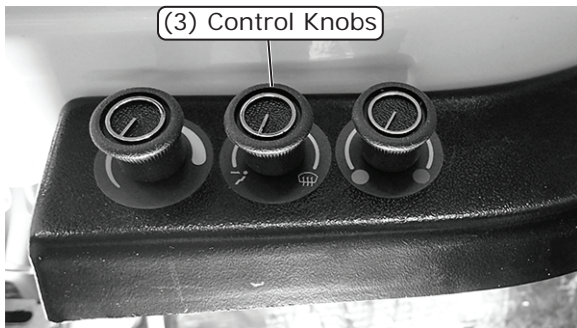

Photo 5

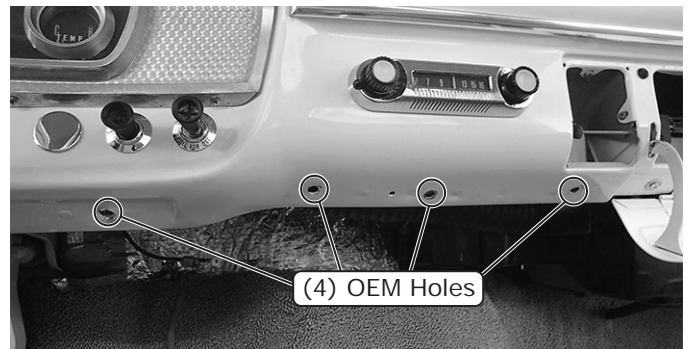
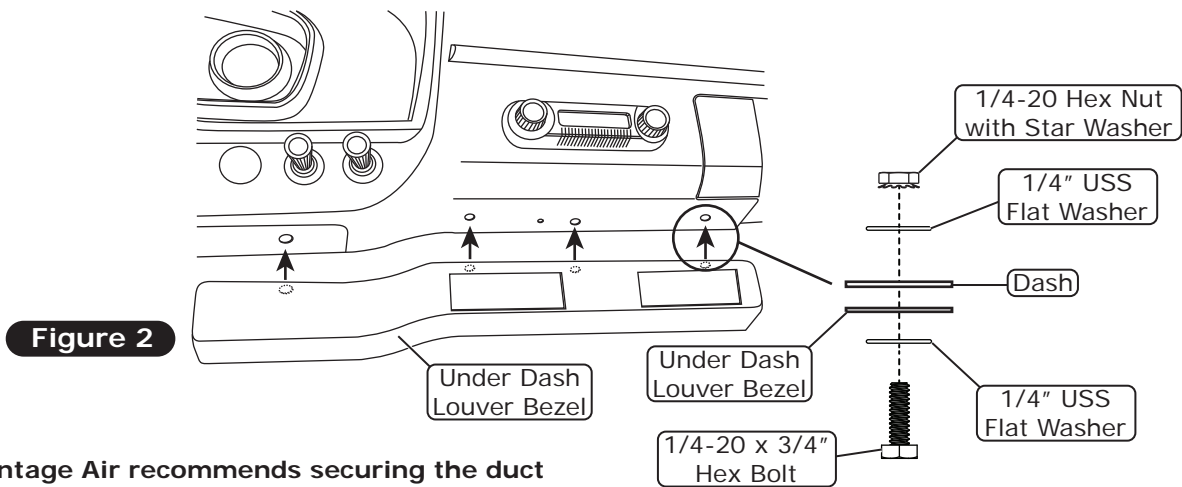

Photo 6



NOTE: Vintage Air recommends securing the duct hoses to the hose adapters before fully inserting the louvers into the bezel. Once the louvers are installed, they can be difficult to remove.

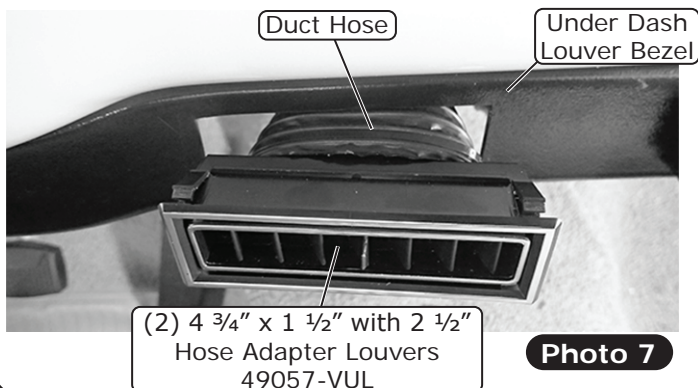

Photo 7



Photo 8



www.vintageair.com

Final Wiring from Engine Bay

NOTE: The following connections are critical to the performance of the system. Before making connections refer to **Quality Crimp Guidelines, Page 38**.

1. Route the power and ground wires toward the battery (See Photo 1, below)
2. Install the supplied heat shrink over the 12 AWG orange standard fuse holder assembly wire, and crimp it to the 12 AWG orange wire from the main wiring harness (See Photo 2, below). Slide the heat shrink over the crimp, then apply heat.
3. Install the supplied heat shrink over the 16 AWG black mini fuse holder assembly wire, and crimp it to the 16 AWG red wire from the main wiring harness (See Photo 3, below). Slide the heat shrink over the crimp, then apply heat.
4. Install fuses into the holders (See Photos 4, 5 and 6, below).
5. Install the supplied heat shrink over the white ground wires, then crimp on the supplied eyelets (See Photo 7, below). Slide the heat shrink over the crimp, then apply heat.

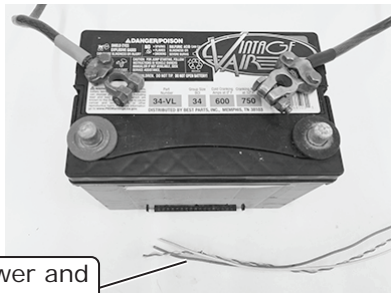

Route power and ground wires toward battery

Photo 1

Crimp 12 AWG orange fuse holder wire to 12 AWG orange wire from main wiring harness



Install heat shrink over 12 AWG orange standard fuse holder assembly wire

Photo 2

Crimp 16 AWG black fuse holder wire to 16 AWG red wire from main wiring harness



Install heat shrink over 16 AWG black mini fuse holder assembly wire

Photo 3

Install fuses into fuse holders

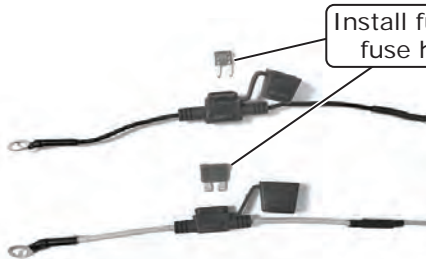

Photo 4



Photo 5



Fuses Installed

Photo 6

Install heat shrink over white ground wires, then crimp on ring terminals

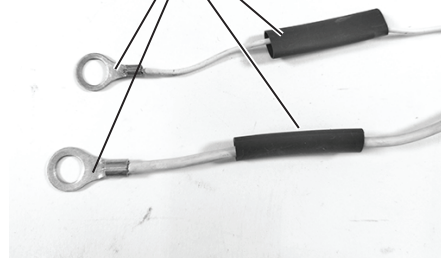

Photo 7



www.vintageair.com

Final Wiring from Engine Bay (Cont.)

NOTE: Both white wires can be crimped to the larger ring terminal. Install the heat shrink. Strip the wire, twist together and trim to length. Crimp on the ring terminal, then slide the heat shrink over and apply heat (See Photos 8, 9 and 10, below).

6. Connect the ground wiring eyelets to the negative battery terminal connector (See Photos 11 and 12, below).
7. Connect the positive wiring eyelets to the positive battery terminal connector (See Photos 13 and 14, below).
8. Wiring completed (See Photo 15, below). **NOTE: Do not connect power until installation is completed.**

Both white wires can be crimped to larger ring terminal. Install heat shrink, then strip wires, twist together and trim to length.



Photo 8



Photo 9

Crimp on ring terminal, then slide heat shrink over and apply heat

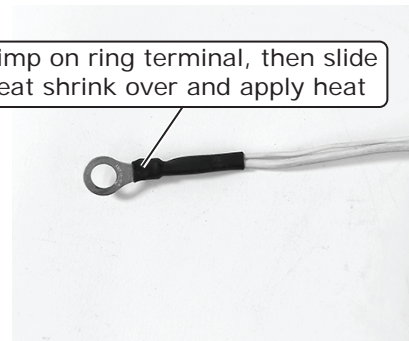

Photo 10

Connect ground wiring eyelets to negative battery terminal
NOTE: Either connection application can be used.



Photo 11



Photo 12

Connect positive wiring eyelets to positive battery terminal
NOTE: Either connection application can be used.

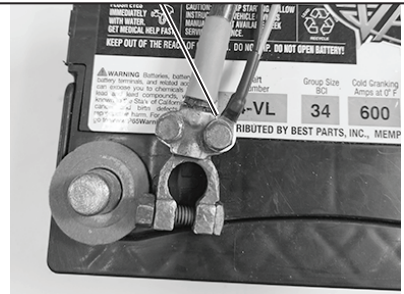
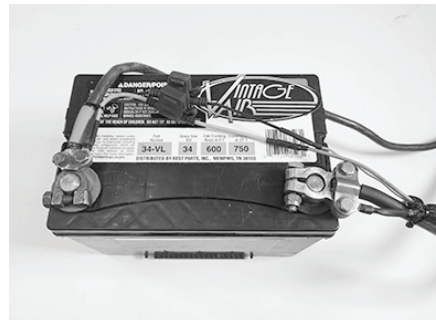

Photo 13

Connect positive wiring eyelets to positive battery terminal
NOTE: Either connection application can be used.



Photo 14



Completed Installation Shown

NOTE: Do not connect power until installation is completed.

Photo 15



www.vintageair.com

Final Wiring from Inside Cab

1. Locate the blower speed control wire/plug on the evaporator module, connect the plug to the corresponding lead coming off of the main harness (See Photo 1, below).
2. Once connected, route the harness between the firewall and evaporator module and up toward the dashboard. **NOTE: Ensure the wires are clear of the metal heater lines and blower motor.** Connect the block plug to the corresponding port on the ECU (See Photo 2, below).
3. Route the violet and tan braided wire behind the dash towards the driver compartment (See Photo 3, below). The violet wire will be connected to the keyed on power (+), the tan wire will not be used in this application.
4. Route the wiring harness from the A/C control knobs behind the dash to the glove box area. Connect it to the corresponding port on the ECU (See Photos 4 and 5, below).
5. Secure all the wires to prevent chafing (See Photo 6, below).

Blower speed control wire/plug on evaporator module

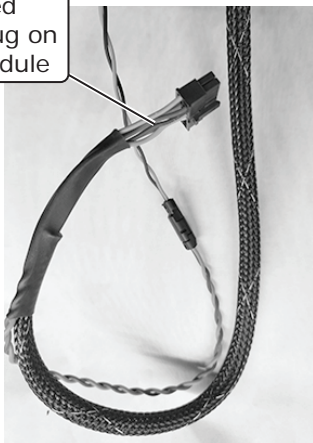

Photo 1

Connect block plug to corresponding port on ECU

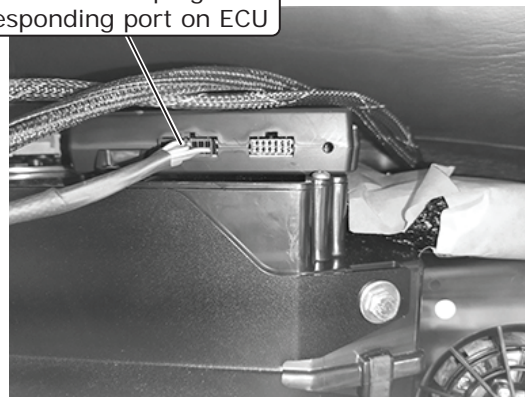

Photo 2

Route violet and tan braided wire behind dash towards driver compartment

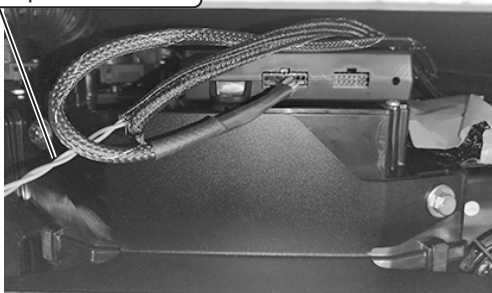

Photo 3

Route wiring harness from A/C control knobs behind dash to glove box area

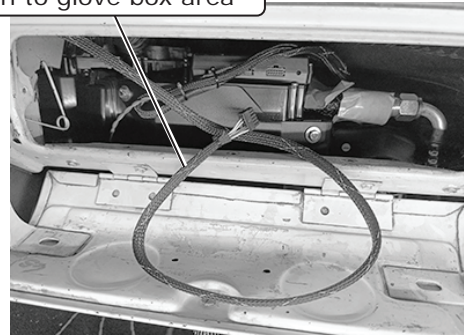

Photo 4

Connect wiring harness to corresponding port on ECU

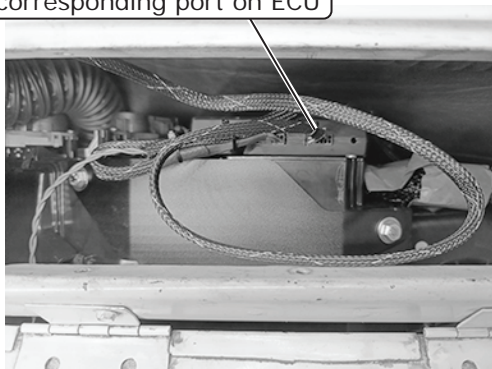

Photo 5

Secure all wires to prevent chafing

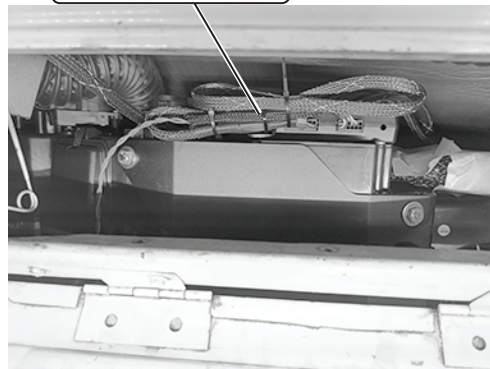

Photo 6



www.vintageair.com

Compressor Lead Installation

1. Once the compressor and A/C lines are installed, locate the blue compressor lead with bullet connector.
2. Connect the bullet connector to the lead on the A/C compressor, then loom and route the wire along the #10 A/C hose from the compressor to the fender, securing it with zip ties (See Photos 1 and 2, below).
3. Insert the spade end of the wire through the previously installed grommet on the inner fender (See Photo 3, below).
4. Connect the spade terminal to the other end of the binary switch (See Photo 4, below), loom and secure the excess wire (See Photos 5 and 6, below).

Connect bullet connector to lead on A/C compressor

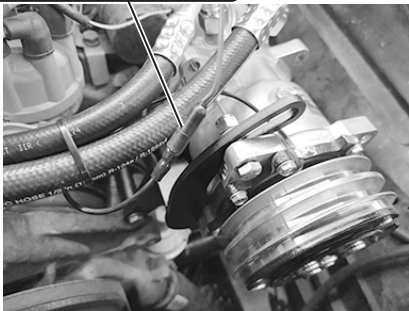
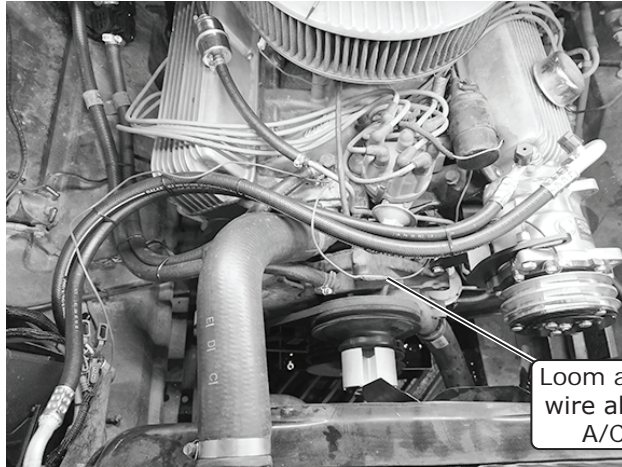

Photo 1



Loom and route wire along #10 A/C hose

Photo 2

Insert spade end of wire through previously installed grommet on inner fender

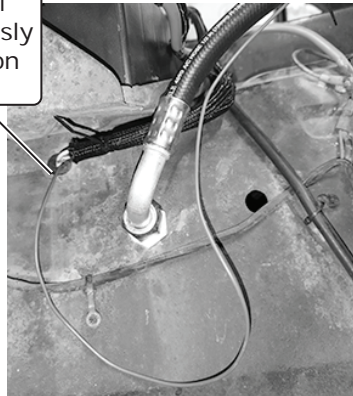

Photo 3

Connect spade terminal to other end of binary switch



Photo 4

Loom and secure excess wire

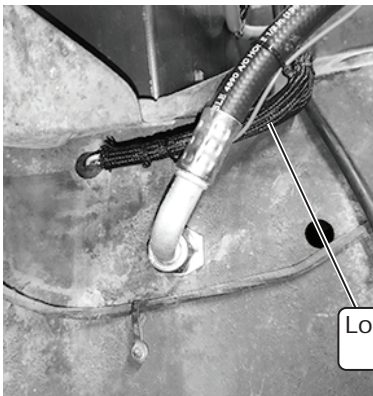

Photo 5

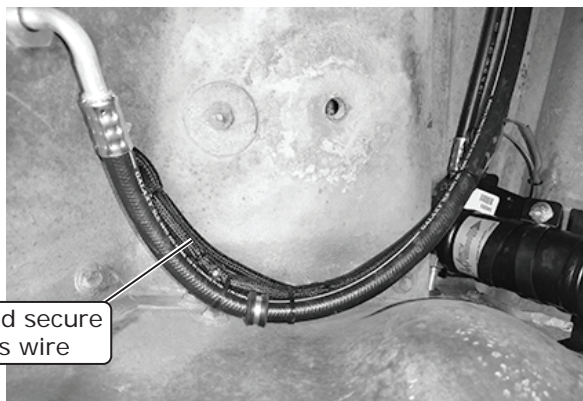

Photo 6



www.vintageair.com

Final Steps: Installation Check

Installation Check	
ITEM TO CHECK	Procedure
<input type="checkbox"/>	<p>ECU</p> <p>If no blinking is observed after 1 minute of turning the ignition on, go to the next check.</p> <p>If repetitive blinking is observed, go to the Advanced Diagnostics Section to diagnose.</p>
<input type="checkbox"/>	<p>Blower speed control</p> <p>Set the blower speed control to OFF, <u>confirm that the blower is off</u>.</p> <p>Position the blower speed control to LOW then MEDIUM and then HIGH. <u>At each setting confirm that the blower speed increases</u>, do this by feeling for the amount of air coming from the unit and hearing the blower speed increase.</p>
<input type="checkbox"/>	<p>Mode control</p> <p>Set the MODE control to the DASH position. <u>Confirm that air is being blown at the dash vents</u>.</p> <p>Set the MODE control to the FLOOR position. <u>Confirm that air is being blown at the floor vents</u>.</p> <p>Set the MODE control to the DEFROST position. <u>Confirm that all air is being blown from the defrost vents</u></p> <p>If heater lines are installed:</p> <p>Set the MODE control to the DASH position. Set the TEMP control to the MAX HEAT position. <u>Confirm that HOT air is coming from the dash vents</u>.</p>
<input type="checkbox"/>	<p>Temperature control</p> <p>If system is charged:</p> <p>Set the TEMP control to the MAX COOL position. <u>Confirm that COLD air is coming from the dash vents</u>.</p> <p>Also <u>confirm that the compressor "clicks" on</u> when adjusting the TEMP control from the MAX HEAT position to the MAX COOL position.</p>
<input type="checkbox"/>	<p>AC Indicator (If applicable)</p> <p>While the MODE control is set to the DASH position, and the TEMP control is set to the MAX COOL/MIN HEAT position, <u>confirm that the blue AC Indicator light is on</u>.</p>
<input type="checkbox"/>	<p>Backlight (If applicable)</p> <p>If your control panel has backlight capabilities and has been wired, turn the dash lamp on and <u>confirm that the AC panel's legend is lit</u>.</p>
<input type="checkbox"/>	<p>Fittings</p> <p>Verify AC and Heater fittings are all tight.</p>



www.vintageair.com

Final Steps: Completing the Install

1. Install the duct hoses onto the evaporator module (See Duct Hose Routing, Page 37).
2. Install the new glove box into the glove box opening and secure it using (5) #8 x 1/2" pan head screws (See Photos 1 and 2, below). **NOTE: To ease the glove box into the opening, slide it in towards the kick panel, and once it is all in, install it onto the back of the dash.**
3. Reinstall all other previously removed items.
4. Fill radiator with at least a 50/50 mixture of approved antifreeze and distilled water. It is the owner's responsibility to keep the freeze protection at the proper level for the climate in which the vehicle is operated. Failure to follow antifreeze recommendations will cause heater core to corrode prematurely and possibly burst in A/C mode and/or freezing weather, voiding your warranty.
5. Double check all fittings, brackets and belts for tightness.
6. Vintage Air recommends that all A/C systems be serviced by a licensed automotive A/C technician.
7. Evacuate the system for a minimum of 45 minutes prior to charging, and perform a leak check prior to servicing.
8. Charge the system to the capacities stated on Page 4 of this instruction manual.
9. See Operation of Controls procedures on Page 41.

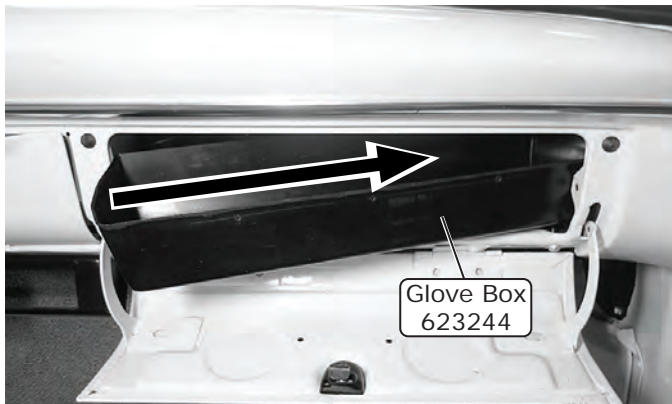

Photo 1

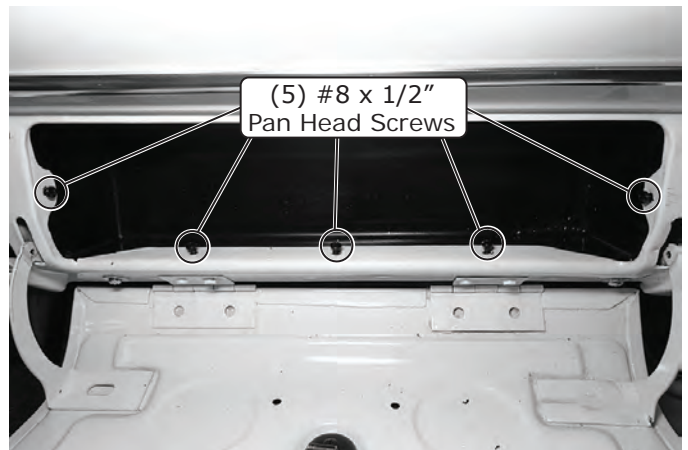

Photo 2



www.vintageair.com

Duct Hose Routing

NOTE: For the system to function optimally, the duct hoses must be routed as directly as possible, taking care to avoid kinks, sharp bends and unnecessary length. Vintage Air supplies duct hoses in continuous lengths that will need to be cut to size depending on application. Before cutting, familiarize yourself with the installation instructions and verify the routing will work with your application. For custom hose routing, additional hose may be needed and can be purchased from Vintage Air.

1. Stretch the duct hose until there is no slack, measure, mark and cut hose to size (See Photo 1, below).

Stretch, measure, mark and cut hose to size



Photo 1

Disclaimer: Before cutting duct hose to length, verify the routing will work for your application.

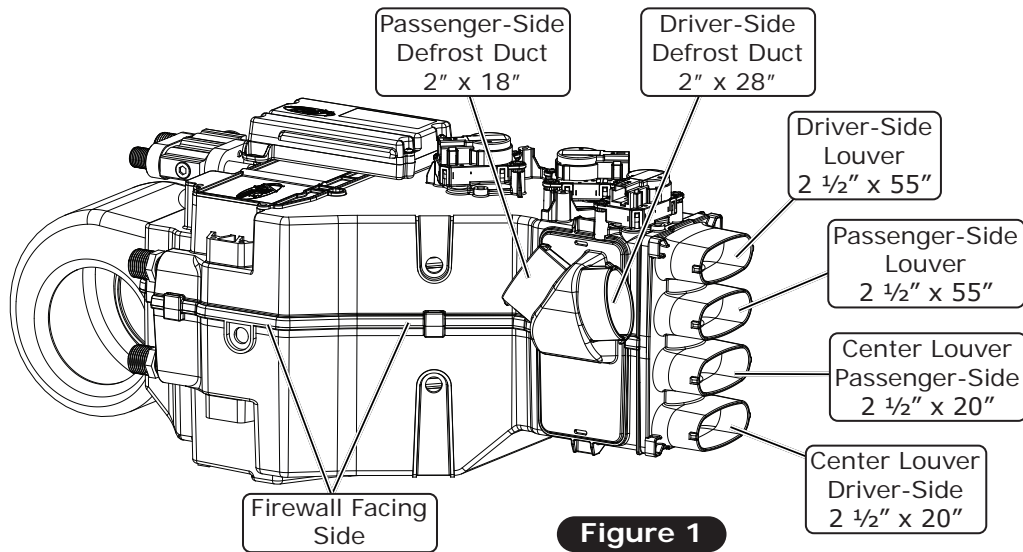

Figure 1



NOTE: ECU must be placed away from water and humidity, and also be accessible for servicing. If relocating, connectors must be positioned towards the bottom.

Position connectors towards bottom

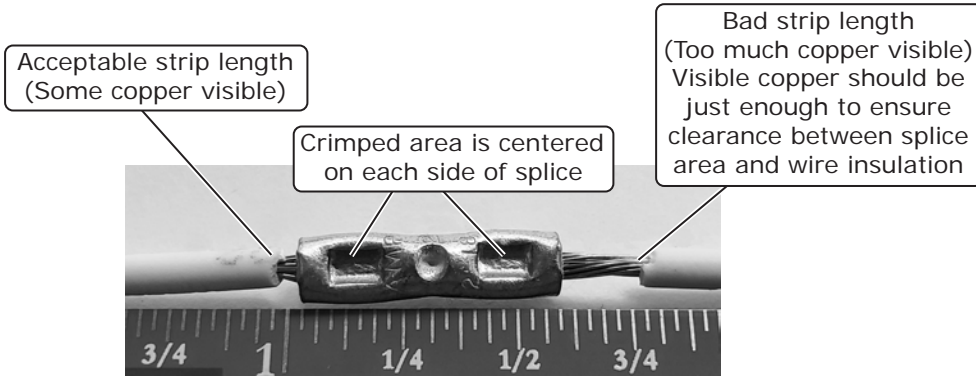

Photo 1

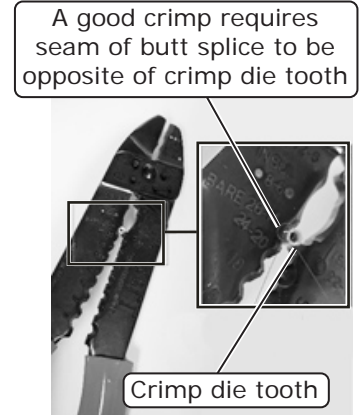

Photo 2

Good Ring Terminal Crimp Bad Ring Terminal Crimp



Photo 3

Crimp area is centered on barrel

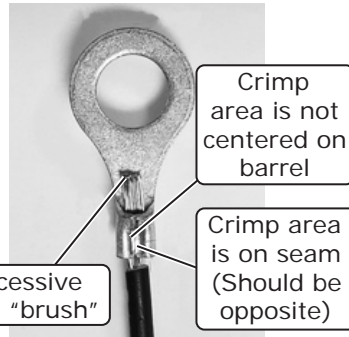

Photo 4



Photo 5

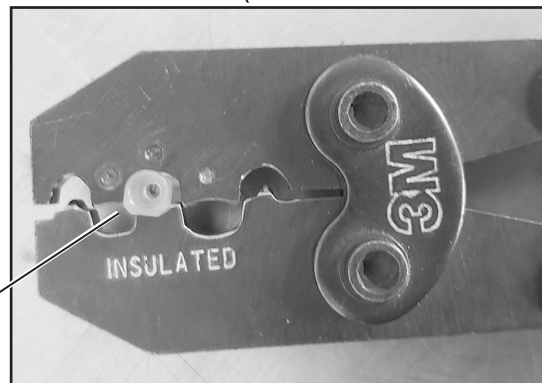

Photo 5a

Use a ratcheting crimp tool for insulated barrel terminals when crimping the provided female insulated terminal. Ensure terminal is inserted in appropriate position before crimping.



www.vintageair.com

Gen 5 Wiring Diagram

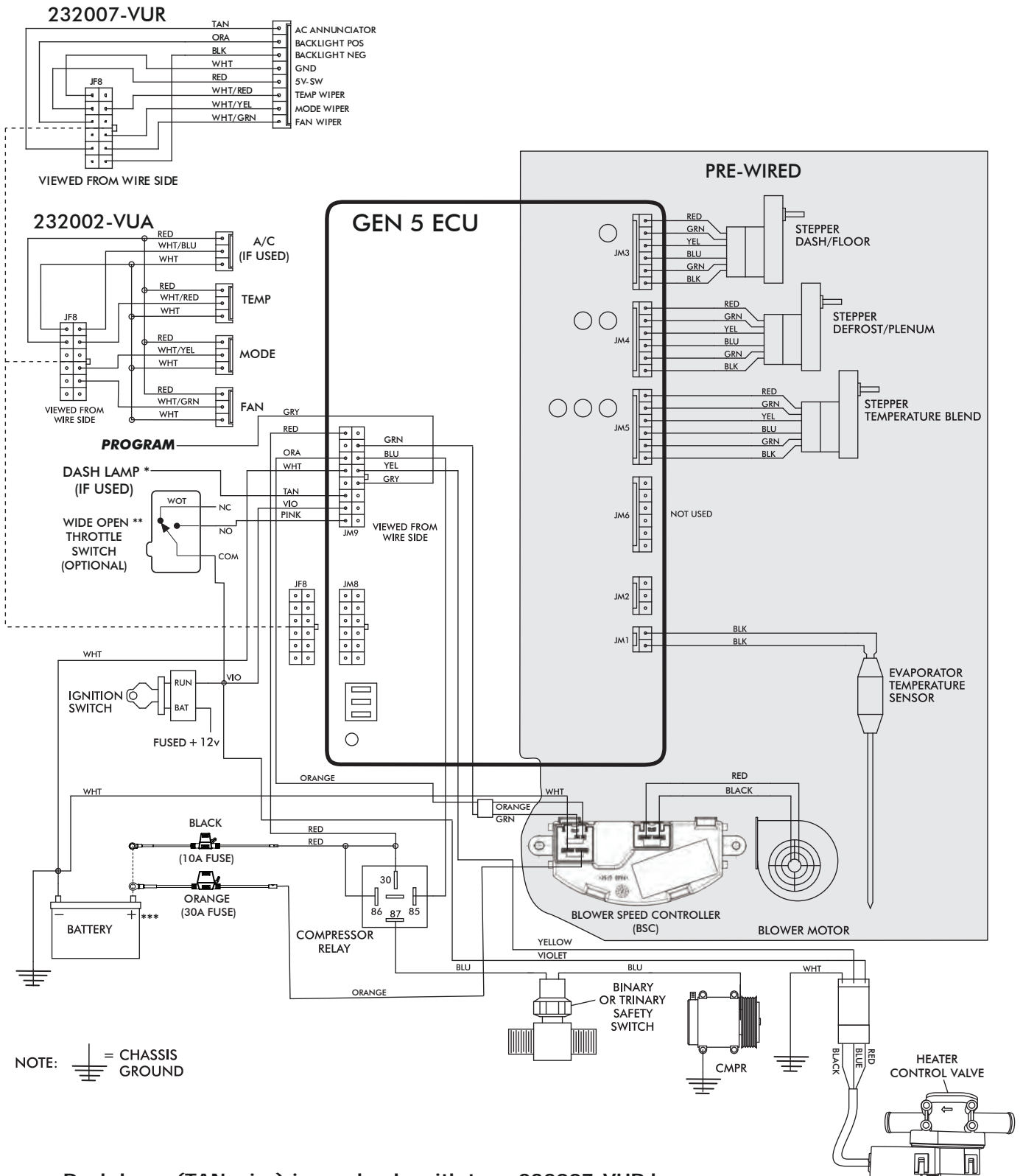

NOTE: = CHASSIS GROUND

- * Dash lamp (TAN wire) is used only with type 232007-VUR harness.
- ** Wide open throttle switch contacts close only at full throttle, which disables A/C compressor.
- *** Install fuse assemblies at or as near to the battery as possible.



www.vintageair.com

Gen 5 Wiring Instructions

WIRING HARNESS (231505) ↓

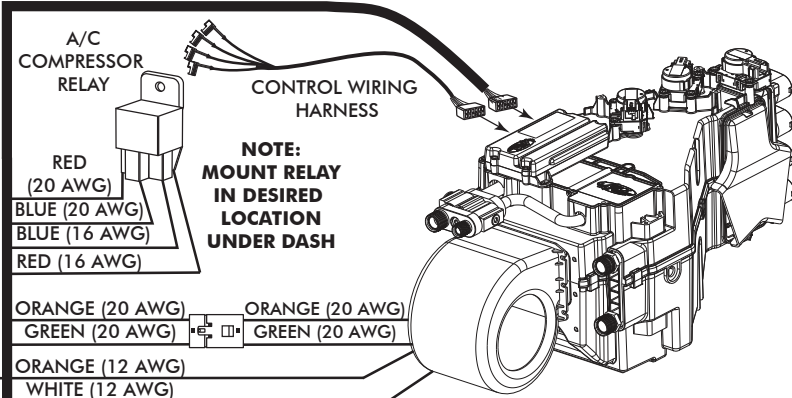

Ignition Switch:
Using provided butt splice (PN 226004), connect the 20 AWG violet wire to a 5A fused and switched 12V source such as Key On.

Wide Open Throttle Switch (Optional):
If a wide open throttle switch is required, connect the 20 AWG pink wire to a normally open switch that, when closed, connects a fused and switched 12V source to the pink wire. See Gen 5 wiring diagram for an example.

Dash Light (Optional):
If using a Vintage Air control panel with back light, connect the 20 AWG tan wire to the vehicle's dash back light 0-12V using provided butt splice (PN 226004).

WIRING HARNESS (232020) →

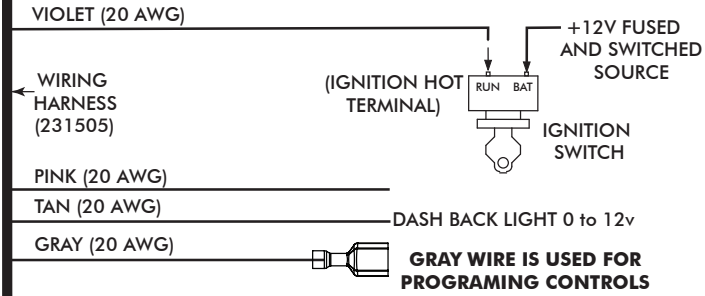

FIREWALL FIREWALL

WIRING HARNESS (232020) →

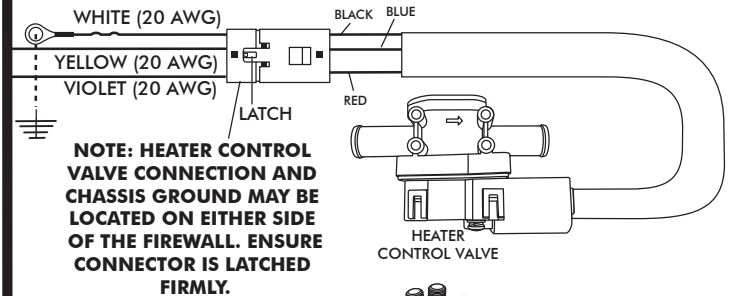

Heater Control Valve:
Connect the Violet/Yellow/White twisted branch with 3 position connector into the heater control valve connector. Ensure that the mating latch is fully seated.

Binary/Trinary & Compressor:
Binary Switch: Terminate provided insulated female terminal (PN 23172-VUW) to the blue 16 AWG wire. Connect as shown.
Trinary Switch: Connect according to trinary switch wiring diagram.

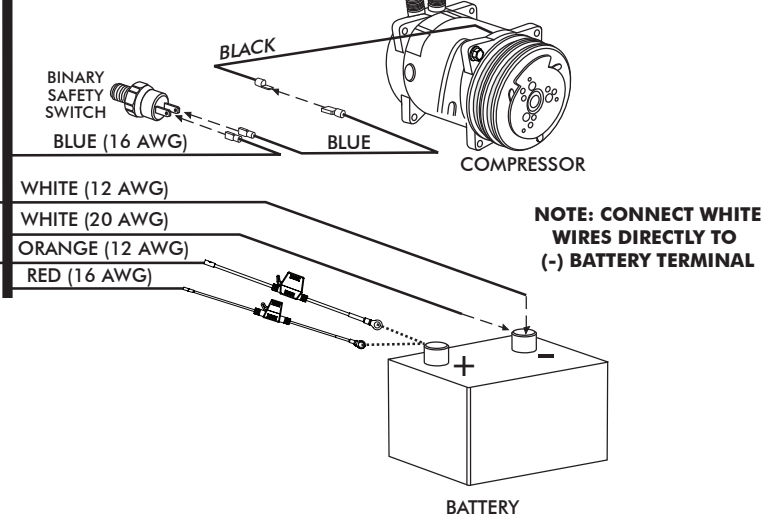

Battery Connections:
ECU Ground: Terminate provided ring terminal (PN 226110) to 20 AWG white wire from the 231505 wire assembly and install at battery.
ECU PWR: Terminate provided fuse assembly with black leads (PN 233012) to the 16 AWG red wire from the 231505 wire assembly. Install provided 10A Red Mini Fuse (PN 226118). Install at battery.
Blower Speed Controller (BSC) Ground: Terminate provided ring terminal (PN 226111) to 12 AWG white wire from the 232020 wire assembly and install at battery.
Blower Speed Controller (BSC) PWR: Terminate provided fuse assembly with orange leads (PN 233008) to the 12 AWG orange wire from the 232020 wire assembly. Install provided 30A Green ATO/ATC Fuse (PN 226125). Install at battery.



www.vintageair.com

Operation of Controls

On Gen IV or Gen 5 systems with three lever/knob controls, the temperature control toggles between heat and A/C operations. To activate A/C, move the temperature lever/knob all the way to cold and then back it off to the desired vent temperature. For heat operation, move the temperature lever/knob all the way to hot and then adjust to the desired vent temperature. The blower will momentarily change speed, each time you toggle between operations, to indicate the change.

Blower Speed

This lever/knob controls blower speed, from OFF to HI.

Mode Control

This lever/knob controls the mode positions, from DASH to FLOOR to DEFROST, with a blend in between.

Temperature Control

This lever/knob controls the temperature, from HOT to COLD.

Blower Speed

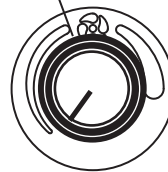

Mode Control



Temperature Control



A/C Operation

Blower Speed

Adjust to desired speed.

Mode Control

Adjust to desired mode position (DASH position recommended).

Temperature Control

For A/C operation, adjust to coldest position to engage compressor (Adjust between HOT and COLD to reach desired temperature).

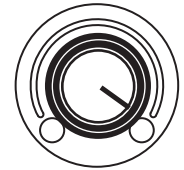

Heat Operation

Blower Speed

Adjust to desired speed.

Mode Control

Adjust to desired mode position (FLOOR position recommended).

Temperature Control

For maximum heating, adjust to hottest position (Adjust between HOT and COLD to reach desired temperature).

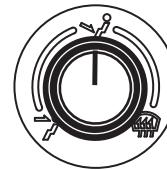

Defrost/De-fog Operation

Blower Speed

Adjust to desired speed.

Temperature Control

Adjust to desired temperature.

Mode Control

Adjust to DEFROST position for maximum defrost, or between FLOOR and DEFROST positions for a bi-level blend (Compressor is automatically engaged).





www.vintageair.com

Troubleshooting Guide

This printed troubleshooting guide is our basic guide that covers common installation problems. To see our advanced diagnostics and troubleshooting guide, please refer to the following page for instructions on how to download the complete guide.

WARNING: While troubleshooting the system, never probe connector terminals from the front mating side, only back probe.

WARNING: While troubleshooting the system, never use automotive check lights.

Symptom	Condition	Checks	Actions	Notes
1. Blower stays on high speed with ignition on.	No other functions work.	Check for damaged pins or wires in the control panel wire assembly and mating header at ECU.	If found damaged, replace wire assembly or ECU.	If fuse continues to blow, there is a serious problem in the wiring. Check all wiring and ensure the wire is not damaged and shorting out along its route.
	All other functions work.	Check for a bad ECU GND. Check for damaged pins or wires in the control panel wire assembly and mating header at ECU. Check if Blower power fuse is blown. Check for a bad ECU GND.	If found damaged, replace wire assembly or ECU. Replace fuse. Repair connection.	
2. Compressor will not turn on (All other functions work).	System is not charged.	System must be charged for compressor to engage.	Charge system.	Danger: Never bypass safety switch with engine running. Serious injury can result.
	System is charged.	Check for faulty A/C potentiometer or associated wiring (not applicable to 3-pot controls).	Check continuity to ground on white control head wire. Check for 5V on red control head wire.	To check for proper pot function, check voltage at white/red wire. Voltage should be between 0V and 5V, and will vary with pot lever position.
		Check for disconnected or faulty thermistor.	Check 2-pin connector at ECU housing.	Disconnected or faulty thermistor will cause compressor to be disabled.
3. Compressor will not turn off (All other functions work).	Compressor will not turn off (All other functions work).	Check for faulty A/C potentiometer or associated wiring.	Repair or replace pot/control wiring.	Red wire at A/C pot should have approximately 5V with ignition on. White wire will have continuity to chassis ground. White/Red wire should vary between 0V and 5V when lever is moved up or down.
		Check for faulty A/C relay.	Replace relay.	



www.vintageair.com

Troubleshooting Guide (Cont.)

Symptom	Condition	Checks	Actions	Notes
4. System will not turn on, or runs intermittently.	Works when engine is not running; shuts off when engine is started	Noise interference from either ignition or alternator.	Install capacitors on ignition coil and alternator. Ensure good ground at all points. Relocate coil and associated wiring away from ECU and ECU wiring. Check for burned or loose plug wires.	Ignition noise (radiated or conducted) will cause the system to shut down due to high voltage spikes. If this is suspected, check with a quality oscilloscope. Spikes greater than 16V will shut down the ECU. Install a radio capacitor at the positive post of the ignition coil (see radio capacitor installation bulletin). A faulty alternator or worn out battery can also result in this condition.
	Will not turn on under any conditions.	Verify connections on power lead, ignition lead, and both white ground wires. Verify battery voltage is greater than 10 volts and less than 16 while engine is running.	Check for power at ECU, and confirm ignition is being applied to ECU properly. Verify proper meter function by checking the condition of a known good battery.	
5. Loss of mode door function.	No mode change at all.	Check for damaged mode switch or potentiometer and associated wiring.		
	Blower turns on and off rapidly.	Battery voltage is at least 12V. Battery voltage is less than 12V.	Ensure all system grounds and power connections are clean and tight. Charge battery.	System shuts off blower at 10V. Poor connections or weak battery can cause shutdown at up to 11V.
7. Erratic functions of blower, mode, temp, etc.		Check for damaged switch or pot and associated wiring.	Repair or replace.	

Advanced Diagnostics and Troubleshooting Guide

If after referencing the Troubleshooting Guide, the issue is not resolved, move to The Advanced Diagnostics and Troubleshooting Guide that covers the following:

- **ECU Diagnostics Codes**
 1. ECU Blink Sequence
 2. Firmware Version Number
 3. ECU Model Number
 4. ECU Start-Up Blink Sequence
 5. Diagnostic Codes
- **Complete Advanced Troubleshooting Guidelines**

Access the latest version of the Advanced Diagnostics and Troubleshooting Guide by scanning the following QR code on your mobile device:



You can also access the guide by typing the following address into your web browser:

https://www.vintageair.com/instructions_pdf/905000.pdf



www.vintageair.com

Packing List: Evaporator Kit (751649)

No.	Qty.	Part No.	Description
1.	1	765125	Gen 5 Magnum Module with 444 ECU
2.	1	791649	Accessory Kit

Checked By: _____
Packed By: _____
Date: _____

1



**Gen 5 Magnum Module
with 444 ECU
765125**

2

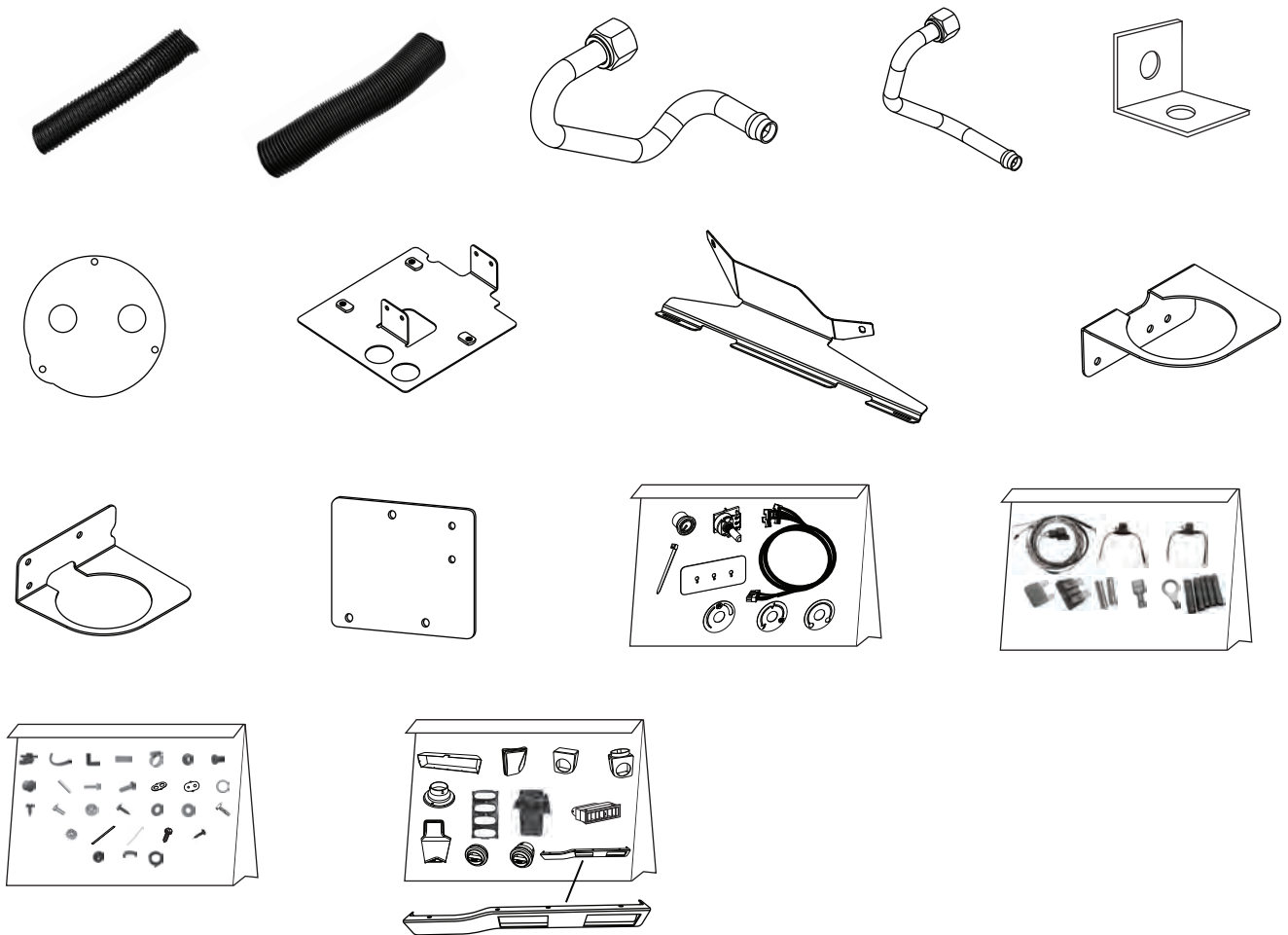

**Accessory Kit
791649**

**NOTE: Images may not depict actual parts and quantities.
Refer to packing list for actual parts and quantities.**