



## **Edelbrock Victor II Intake Manifold**

**For Chrysler 5.7L (Eagle) and 6.1L Gen III HEMI Engines**

**Part #7179**





# Edelbrock Victor II Intake Manifold

## For Chrysler Gen III HEMI Engines

### Installation Instructions

**PLEASE** study these instructions carefully before beginning this installation. You should be familiar with and comfortable working on your vehicle. If you do not feel comfortable performing this installation, it is recommended to have the installation completed by a qualified shop. If you have any questions, please call our **Technical Hotline at: 1-800-416-8628**, 7:00 am - 5:00 pm, Pacific Standard Time, Monday through Friday.

**NOTE: Proper installation is the responsibility of the installer. Improper installation will void the manufacturer's warranty and may result in poor performance and engine damage.**

**INTRODUCTION:** Thank you for purchasing the Edelbrock Victor II intake manifold for Chrysler Gen III Hemi Engines. The Edelbrock Victor II intake manifold combines long, tapered runners with a large plenum for outstanding performance. This manifold is intended for 5.7L (Eagle) and 6.1 engine applications (excluding trucks).

**PN 7179 CONTENTS:**

<u>QTY.</u>	<u>Description</u>	<u>QTY.</u>	<u>Description</u>
☐ 1	Victor II Intake Manifold	☐ 2	M4 x 8mm Socket Head Bolt (6.1/6.4 Map Sensor)
☐ 1	Throttle Body Gasket	☐ 1	M4 x 16mm Socket Head Bolt (5.7 Map Sensor)
☐ 1	Cast Oil Fill	☐ 8	M6 x 90mm Socket Head Bolt (Manifold to Heads)
☐ 1	Oil Fill Gasket	☐ 2	M6 x 45mm Socket Head Bolt (Manifold to Heads)
☐ 1	Cast Plenum Cover	☐ 10	M6 x 20mm Hex Flange Bolt (Plenum Cover)
☐ 1	Plenum Cover Gasket	☐ 2	M6 x 25mm Hex Flange Bolt (Oil Fill to Manifold)
☐ 1	MAP Sensor Bracket (For Use with 5.7 MAP Sensor)	☐ 1	M6 x 55mm Hex Flange Bolt (Oil Fill to Manifold)
☐ 1	PCV Valve	☐ 4	M6 x 40mm Hex Flange Bolt (Throttle Body)
		☐ 1	Aluminum Spacer (For Use with 5.7 MAP Sensor)

**VEHICLES:** Intended for Dodge Challengers/Chargers and Chrysler 300 vehicles. *Not intended for installation on Dodge Ram Trucks.*

**FUEL RAIL:** Requires Edelbrock Fuel Rail kit PN 3647 (Sold Separately).

**FUEL INJECTORS:** Intended to fit stock size fuel injectors.

**INTAKE GASKETS:** Port exits use stock O-ring type gaskets.

**THROTTLE BODY:** Design for use with the OEM 80mm throttle body or the OEM Hellcat 92mm throttle body.

**AIR INTAKE SYSTEM:** 7179 uses the 5.7/6.1 throttle body location and orientation.

**5.7L Engines:** Use the stock or stock replacement air intake systems.

**6.1L Engines:** Use stock or stock replacement air intake systems.

**PCV SYSTEM:**

**Driver Side:** A fuel and oil resistant hose should be routed from the fitting on the oil fill to the intake tube (not included).

**Passenger Side:** A fuel and oil resistant hose should be routed from the provided PCV valve to the fitting on the manifold located behind the throttle body (not included).

**WIRING:** *This manifold is NOT intended for installation on vehicles with OEM active runner controls.*

**ENGINE CALIBRATION:** An OEM engine calibration and OEM 80mm throttle body is required for emissions controlled vehicles. A custom calibration is required when installing the OEM Hellcat 92mm throttle body which is allowed for race vehicles or for engine swaps into pre-pollution controlled vehicles only. It is never recommended to install this manifold without a proper engine calibration.



# Edelbrock Victor II Intake Manifold

## For Chrysler Gen III HEMI Engines

### Installation Instructions

#### Manifold Installation

This installation guide is intended to cover multiple engine applications. Depending on the vehicle year and model, images and procedures below may differ. If you have any questions call the **Edelbrock Tech line at (800)-416-8628**.

1. Disconnect the negative battery terminal located in the trunk of the vehicle. Secure the cable so it cannot make contact with the battery terminal. **NOTE: Ensure the trunk is not fully closed while the battery is disconnected as it may be difficult to gain access and open from the inside.**



2. Remove the driver side PCV hose.

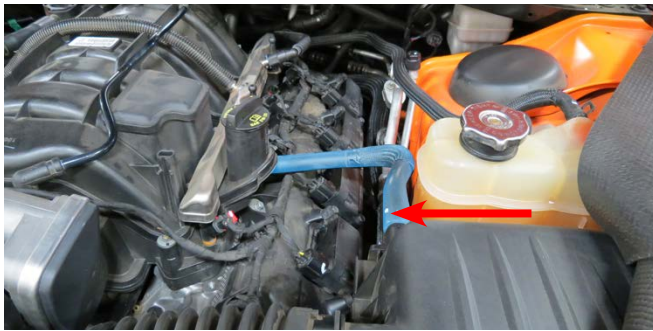

3. Loosen the worm clamps securing the air inlet tube to the airbox and throttle body. Disconnect the engine harness from the IAT sensor and remove the air inlet tube. Using a 8mm socket, remove the bolt securing the stock airbox and remove the airbox.



4. Remove any decorative engine cover(s) and foam isolators over the fuel rails.



5. Remove the EVAP hose from the fitting at the front of the manifold. **NOTE: Later 5.7L applications may have the EVAP solenoid mounted on the intake manifold. In this case, remove the plastic push pin from the EVAP mounting bracket and pull the solenoid off of the bracket. The EVAP solenoid will be reinstalled later.**

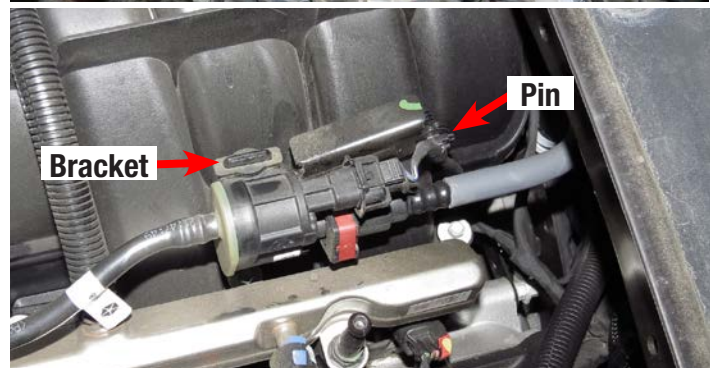



## Edelbrock Victor II Intake Manifold For Chrysler Gen III HEMI Engines Installation Instructions

6. Disconnect the electric throttle control connector from the throttle body.



7. Detach the quick release fuel line from the driver side fuel rail. **CAUTION: Fuel may be under pressure, cover with rag to prevent fuel from spraying.**



8. Unplug all eight (8) fuel injector connectors. Then use an 8mm socket to remove the ten (10) manifold bolts.

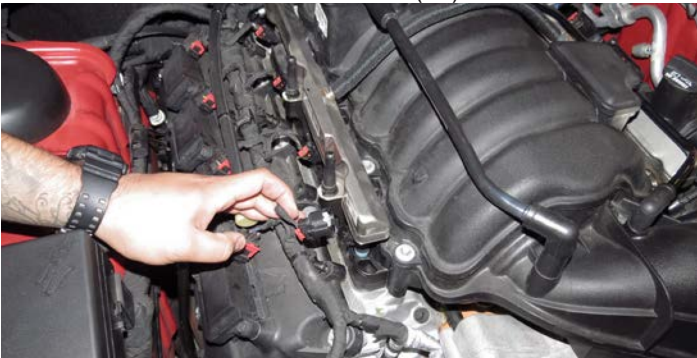

9. Remove the brake booster hose from the back of the manifold.

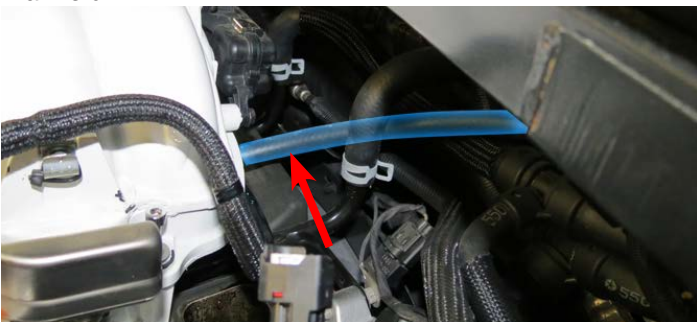

10. Carefully remove the intake manifold and set aside.

11. Use a soft cloth to clean the intake flange of the cylinder heads. Use caution and make sure no dirt or debris falls into the intake ports. Once the intake flanges are cleaned, cover the ports with protective tape to prevent any foreign objects from falling into the ports.



**NOTE: Steps 12-14 are only applicable when reusing the factory fuel injectors. Disregard these steps otherwise.**

12. Using a 14mm deep socket, remove the fuel rails from the factory intake manifold. (6.4L Shown)



13. Firmly lift up on both sides of the factory fuel rail assembly to disengage fuel injectors from the intake manifold. In a gasoline safe container, empty the remaining fuel from the rails.





## Edelbrock Victor II Intake Manifold For Chrysler Gen III HEMI Engines Installation Instructions

14. Remove the eight (8) injector retaining clips and pull the injectors out of the rail. **NOTE:** *The fuel injector clip can be removed by pushing the clip inward (toward the manifold).*



15. Remove the MAP sensor from the factory intake manifold and set aside. On 6.1L engines the, bolt(s) retaining the MAP sensor must be removed. On 5.7L engines the MAP sensor is twist locked into place.



16. Remove and clean all eight (8) intake runner gasket from the factory manifold and set aside.



17. Using an 8mm socket, remove the four (4) bolts securing the throttle body to the factory intake manifold. Clean the throttle body and set aside.

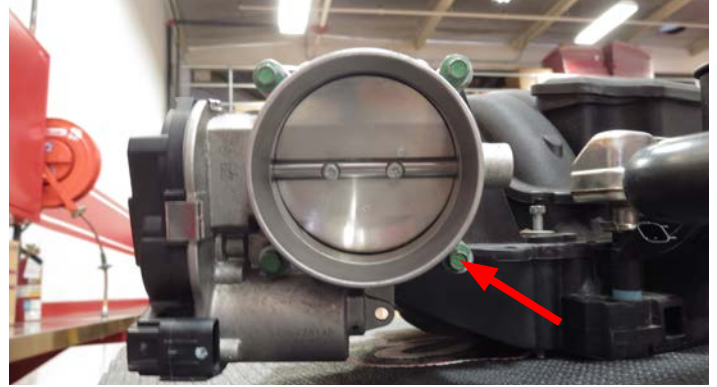

18. Using the provided cover plate, gasket and ten (10) M6 x 20mm bolts, evenly tighten the cover plate to the bottom of the Edelbrock intake manifold.



19. Using the provided oil fill, gasket, two (2) M6 x 25mm bolts and one (1) M6 x 55mm bolt, secure the oil fill to the Edelbrock intake manifold. Remove the oil fill cap from the factory manifold and transfer to the new manifold.

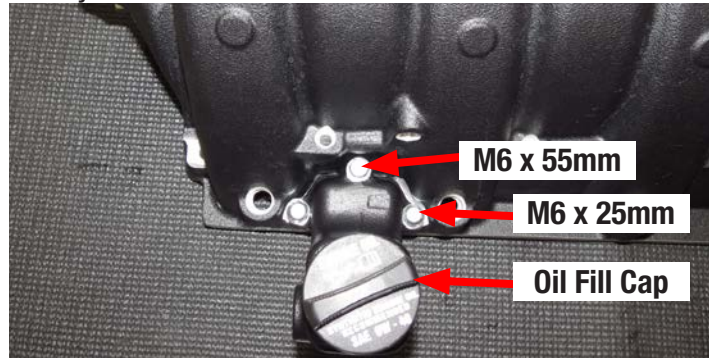



## Edelbrock Victor II Intake Manifold For Chrysler Gen III HEMI Engines Installation Instructions

20. For 6.1L engines, use the provided M4 x 8mm bolt(s) to secure the factory MAP sensor to the back of the Edelbrock intake manifold so the connector is facing up. **NOTE: 5.7L engines must use the provided MAP sensor hold down bracket and aluminum spacer along with one (1) M4 x 16mm bolt.**

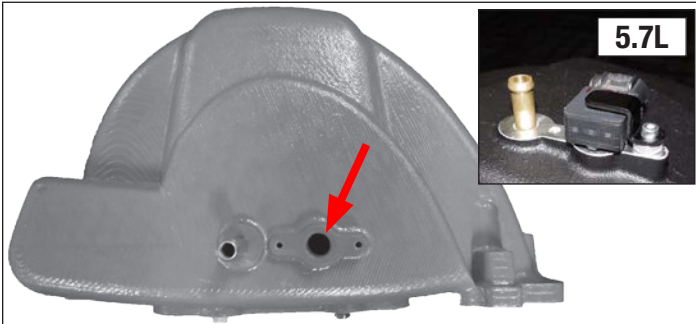

21. Install the provided PCV valve into the Edelbrock intake manifold until the hex makes contact with the casting. DO NOT over tighten.



**NOTE: Steps 22-25 are for using Edelbrock Fuel Rail Kit PN 3647 (Sold Separately).**

22. If reusing the factory fuel injectors, thoroughly clean the injectors and lubricated the O-rings on each end with silicone lube. Install the injectors into the Edelbrock fuel rails.

23. Insert the provided fuel rail spacers into the provisions on the manifold. **NOTE: Production spacers are black in color. Silver spacers shown for demonstration purposes.**



24. Install the fuel rails with injectors onto the manifold making sure the fuel rail spacers stay in place. Firmly and evenly press down on the rails until the injectors are fully seated into the manifold.

25. Secure the fuel rails to the manifold using the four (4) M6 x 65mm bolts and four (4) M6 washers.



26. Using silicone lube, lubricate the factory runner O-rings gaskets removed during step #16 and insert the gaskets into the machined grooves on the Edelbrock intake manifold.

27. Position the Edelbrock manifold in the engine bay as far forward as possible on the cylinder heads and reconnect the MAP sensor harness and brake booster hose at the back of the manifold.



# Edelbrock Victor II Intake Manifold For Chrysler Gen III HEMI Engines Installation Instructions

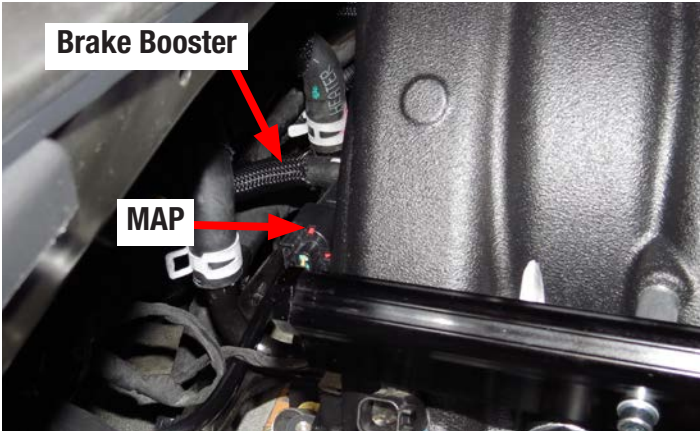

31. When using the OEM 80mm throttle body, use RTV silicone to fill the two (2) holes at the top of the throttle body mounting surface and apply the provided gasket. Note the gasket orientation shown below.



28. Reposition the intake manifold on the cylinder heads so the mounting holes on the manifold line up with the corresponding holes on the cylinder heads.

29. Using the eight (8) M6 x 90mm and two (2) M6 x 45mm Socket Head bolts, secure the intake manifold to the cylinder heads. Use the sequence below to torque the bolts to 9 lb/ft or 108 lb/in. **NOTE: Hole #8 and #10 use the 45mm bolts.**

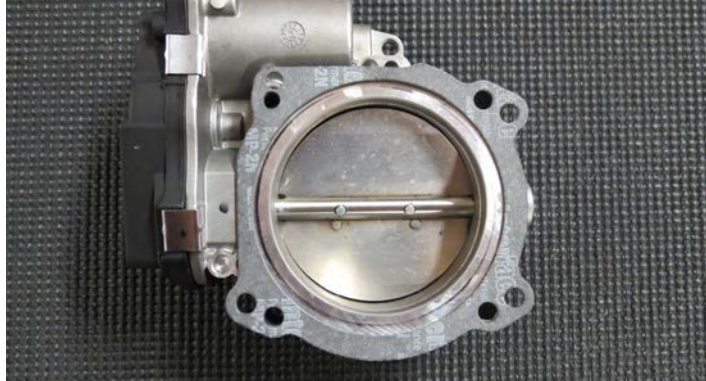
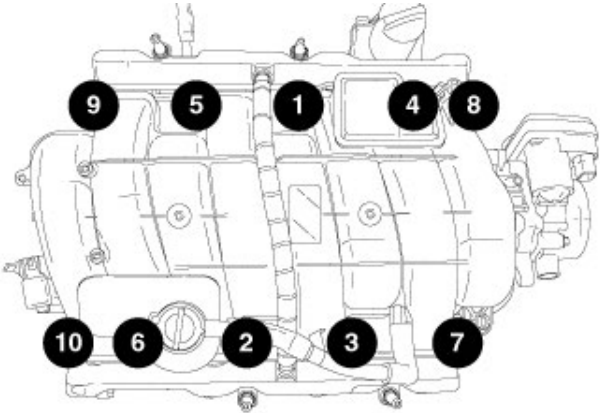

32. Using the provided throttle body gasket and four (4) M6 x 40mm bolts, secure the throttle body to the Edelbrock intake manifold and reconnect the harness.

30. Reconnect the eight (8) fuel injector harness connections and lock them in place by pushing the red locking tab down.





## Edelbrock Victor II Intake Manifold For Chrysler Gen III HEMI Engines Installation Instructions

33. Reinstall the EVAP solenoid (if applicable) then reconnect the EVAP hose to the fitting on the driver side front of the manifold.



34. Using appropriate fuel and oil resistant hose (not included), connect the PCV on the passenger side rear of the manifold to the fitting on the passenger side front of the manifold.



**NOTE: Steps 35-40 are for using Edelbrock Fuel Rail Kit PN 3647 (Sold Separately).**

35. Using a 3/8" fuel line removal tool, remove the factory fuel line from fitting on the passenger side fire wall.



36. Lubricate the O-ring with silicone lube and install the 180° fitting into the front of the passenger side fuel rail. Tighten until the hex makes contact with the rail.



37. Connect the provided fuel input line from the factory fitting on the fire wall to the 180° fitting installed during step #36.



38. Lubricate the O-rings with silicone lube and install the provided 3/8" male quick connect fittings into the rear of each fuel rail. Tighten until the hex makes contact with the rail.





## Edelbrock Victor II Intake Manifold For Chrysler Gen III HEMI Engines Installation Instructions

39. Install the provided fuel rail crossover to the 3/8" male fittings installed during step #38.



40. Lubricate the O-ring with silicone lube and install the provided -6 AN fuel rail plug into the front of the driver side fuel rail. Tighten until the hex makes contact with the rail.



41. On 5.7L and 6.1L engines, reinstall the factory or factory replacement air intake system.

42. Using appropriate fuel and oil resistant hose (not included), connect the crank case breather on the driver side oil fill to the fitting on the air intake tube.

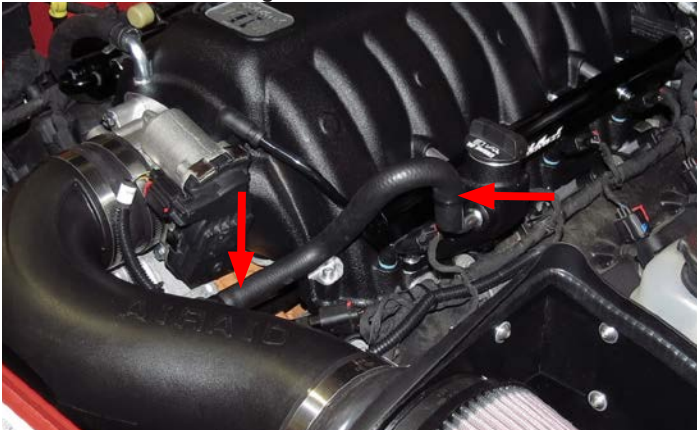

43. Reconnect the IAT sensor harness to the sensor in the intake tube.

44. Reconnect the Negative battery terminal.

45. Turn the ignition on but do not start the vehicle. Check for any fuel leaks. If leaks are present, shut the ignition off immediately and repair leaks before continuing.

Congratulations on the successful installation of your new Edelbrock Victor II Intake Manifold! If you have any questions, please call our Technical Support hotline at 800-416-8628.

